



Operator's Manual

Precedent™ Single Temperature Unit S-750i

Rev. B

July 2022

TK 57041-2-OP-EN

TRANE
TECHNOLOGIES

Introduction

This manual is published for informational purposes only and the information furnished herein should not be considered as all-inclusive or meant to cover all contingencies. If more information is required, consult your Thermo King Service Directory for the location and telephone number of the local dealer.

Thermo King's warranty shall not apply to any equipment which has been "so installed, maintained, repaired or altered as, in the manufacturer's judgment, to affect its integrity."

Manufacturer shall have no liability to any person or entity for any personal injury, property damage or any other direct, indirect, special, or consequential damages whatsoever, arising out of the use of this manual or any information, recommendations or descriptions contained herein. The procedures described herein should only be undertaken by suitably qualified personnel. Failure to implement these procedures correctly may cause damage to the Thermo King unit or other property or personal injury.

There is nothing complicated about operating and maintaining your Thermo King unit, but a few minutes studying this manual will be time well spent.

Performing pre-trip checks and enroute inspections on a regular basis will minimize operating problems. A regular maintenance program will also help to keep your unit in top operating condition. If factory recommended procedures are followed, you will find that you have purchased the most efficient and dependable temperature control system available.

All service requirements, major and minor, should be handled by a Thermo King dealer for four very important reasons:

- They are equipped with the factory recommended tools to perform all service functions.
- They have factory trained and certified technicians.
- They have genuine Thermo King replacement parts.
- The warranty on your new unit is valid only when the repair and replacement of component parts is performed by an authorized Thermo King dealer.

Software License

The product includes software that is licensed under a non-exclusive, non-sublicensable, terminable and limited license to use the software as installed on the product for its intended purpose. Any removal, reproduction, reverse engineering, or other unauthorized use of the software is strictly prohibited. Hacking the product or installing unapproved software may void the warranty. The owner or operator shall not reverse engineer, decompile, or disassemble the software, except and only to the extent that such activity is expressly permitted by applicable law notwithstanding this limitation. The product may include third party software separately licensed as specified in any documentation accompanying the product or in an about screen on a mobile application or website that interfaces with the product.

Customer Satisfaction Survey

Let your voice be heard!

Your feedback will help improve our manuals. The survey is accessible through any internet-connected device with a web browser.

Scan the Quick Response (QR) code or click [Technical Publications TK Americas Feedback](#) to complete the survey.



Table of Contents

Safety Precautions	8
Danger, Warning, Caution, and Notice	8
General Safety Practices	8
Automatic Start/Stop Operation	9
Electrical Hazard	9
Battery Installation and Cable Routing	10
Refrigerant	11
Refrigerant Oil	12
First Aid	12
Safety Decals and Locations	14
Condenser and Evaporator Fans	14
High Voltage Components	14
California Proposition 65 Warning Nameplate	17
Telematics	17
Warning Remote Control Nameplate	17
Unit Description	18
Unit Overview	18
Diesel Engine	18
Extended Life Coolant (ELC)	19
EMI 3000	19
Scroll Compressor	20
Electronic Throttling Valve (ETV)	20
Solar Panel	20
Telematics	20
Control System	21
Operating Modes	22

Diesel Operation	22
Electric Operation	22
Defrost	22
Service Switch	23
CYCLE-SENTRY™ Start-Stop Controls	24
Communication Ports	25
Opening the Front Doors	26
Engine Compartment Components	27
Unit Protection and Control Devices	28
Fuses and Electrical	28
HMI Control Panel	31
Hard Keys	32
Soft Keys	32
Navigation Keys	33
Accept/Enter Key	33
Operation	34
Standard Display	34
TemperatureWatch™ Display	35
Dashboard	36
Alarms	37
Info Log	37
Check Alarm	37
Prevent Shutdown Alarm	38
Shutdown Alarm	38
Turning Unit On	39
Turning Unit Off	40

Changing the Setpoint	41
Defrost	42
Fresh/Frozen Range	44
Starting Diesel Engine	44
Starting Electric Mode	45
Switching From Diesel To Electric	45
Switching From Electric To Diesel	46
Selecting Cycle Sentry/Continuous	47
Temperature Datalogger	49
Main Menu	49
System Menu	49
Hourmeter	51
Engine Submenu	53
Refrigeration Submenu	54
Power Submenu	55
Control Submenu	55
Telematics Submenu	56
Alarm Information Menu	56
Clearing Alarm Codes	58
Pretrip Alarms	59
Alarm Codes When Switching Between Diesel and Electric	59
Important Alarm Notes	59
Flash Drive Menu	59
Download Submenu	60
OptiSet Submenu	61
CEM Update Submenu	63
Language Menu	63
Pretrip Menu	65
Brightness Menu	65
Fuel Prime Menu	67
Electric Standby or Diesel Mode Menu	68

Sleep Mode	70
Manual Pretrip Inspection and Loading Procedures	72
Loading and Inspection Procedures	73
Pre-Loading Inspection	73
Post-Loading Inspection	74
Enroute Inspections	75
Inspection Procedure	75
Inspection Troubleshooting	75
Jump Starting	78
Specifications	82
Engine	82
Refrigeration System	83
Electrical Control System	83
Standby Power Cord Requirements	84
Maintenance Inspection Schedule	85
Serial Number Locations	88
Emergency Cold Line	91
Warranty.....	92
EPA and ARB Supplemental Emissions Warranty Statement.....	92

Safety Precautions

Danger, Warning, Caution, and Notice

Thermo King® recommends that all service be performed by a Thermo King dealer and to be aware of several general safety practices.

Safety advisories appear throughout this manual as required. Your personal safety and the proper operation of this unit depend upon the strict observance of these precautions. The four types of advisories are defined as follows:

▲ DANGER

Hazard!

Indicates an imminently hazardous situation which, if not avoided, will result in death or serious injury.

▲ WARNING

Hazard!

Indicates a potentially hazardous situation which, if not avoided, could result in death or serious injury.

▲ CAUTION

Hazard!

Indicates a potentially hazardous situation which, if not avoided, could result in minor or moderate injury and unsafe practices.

NOTICE

Hazard!

Indicates a situation that could result in equipment or property-damage only accidents.

General Safety Practices

▲ DANGER

Risk of Injury!

Keep hands and loose clothing clear of fans and belts at all times when the unit is operating with the doors open.

⚠ WARNING

Risk of Injury!

Do not apply heat to a closed cooling system. Before applying heat to a cooling system, drain it. Then flush it with water and drain the water. Antifreeze contains water and ethylene glycol. The ethylene glycol is flammable and can ignite if the antifreeze is heated enough to boil off the water.

⚠ CAUTION

Sharp Edges!

Exposed coil fins can cause lacerations. Service work on the evaporator or condenser coils should only be accomplished by a certified Thermo King technician.

Automatic Start/Stop Operation

⚠ CAUTION

Risk of Injury!

The unit can start and run automatically any time the unit is turned on. Turn the unit On/Off switch Off before doing inspections or working on any part of the unit. Please note that only Qualified and Certified personnel should attempt to service your Thermo King unit.

Electrical Hazard

⚠ DANGER

Hazardous Voltage!

Dangerous three phase AC electric power is present whenever the unit is operating in either Diesel Mode or Electric Mode and whenever the unit is connected to a source of external standby power. Voltages of this magnitude can be lethal. Exercise extreme caution when working on the unit. If there is a risk of energized electrical contact, arc, or flash, technicians **MUST** put on all PPE in accordance with OSHA, NFPA 70E, or other local, state, or country-specific requirements for arc flash protection **PRIOR** to servicing the unit. **NEVER PERFORM ANY SWITCHING, DISCONNECTING, OR VOLTAGE TESTING WITHOUT PROPER ELECTRICAL PPE AND ARC FLASHING CLOTHING. ELECTRICAL METERS AND EQUIPMENT MUST BE PROPERLY RATED FOR INTENDED VOLTAGE.**

Battery Installation and Cable Routing

⚠ WARNING

Hazard of Explosion!

An improperly installed battery could result in a fire, explosion, or injury. A Thermo King approved battery must be installed and properly secured to the battery tray.

⚠ WARNING

Hazard of Explosion!

Improperly installed battery cables could result in a fire, explosion, or injury. Battery cables must be installed, routed, and secured properly to prevent them from rubbing, chaffing, or making contact with hot, sharp, or rotating components.

⚠ WARNING

Fire Hazard!

Do not attach fuel lines to battery cables or electrical harnesses. This has the potential to cause a fire and could cause serious injury or death.

⚠ WARNING

Hazard of Explosion!

Always cover battery terminals to prevent them from making contact with metal components during battery installation. Battery terminals grounding against metal could cause the battery to explode.

⚠ CAUTION

Hazardous Service Procedures!

Set all unit electrical controls to the OFF position before connecting battery cables to the battery to prevent unit from starting unexpectedly and causing personal injury.

NOTICE

Equipment Damage!

Do not connect other manufacturer's equipment or accessories to the unit or to the TK Batteries unless approved by Thermo King. Failure to do so can result in severe damage to equipment and void the warranty.

Refrigerant

Although fluorocarbon refrigerants are classified as safe, use caution when working with refrigerants or in areas where they are being used.

⚠ DANGER

Hazardous Gases - Personal Protective Equipment (PPE) Required!

Refrigerant in the presence of an open flame, spark, or electrical short produces toxic gases that are severe respiratory irritants which can cause serious injury or possible death. When working with or around hazardous chemicals, ALWAYS refer to appropriate Material Data Safety Sheets (MSDS) and OSHA/GHS (Global Harmonized System of Classification and Labelling of Chemicals) guidelines for information on allowable personal exposure levels, proper respiratory protection, and handling instructions.

⚠ DANGER

Refrigerant Vapor Hazard!

Do not inhale refrigerant. Use caution when working with refrigerant or a refrigeration system in any confined area with a limited air supply. Refrigerant displaces air and can cause oxygen depletion, resulting in suffocation and possible death. When working with or around hazardous chemicals, ALWAYS refer to appropriate Material Data Safety Sheets (MSDS) and OSHA/GHS (Global Harmonized System of Classification and Labelling of Chemicals) guidelines for information on allowable personal exposure levels, proper respiratory protection, and handling instructions.

⚠ WARNING

Personal Protective Equipment (PPE) Required!

Refrigerant in a liquid state evaporates rapidly when exposed to the atmosphere, freezing anything it contacts. Wear butyl lined gloves and other clothing and eye wear when handling refrigerant to help prevent frostbite. When working with or around hazardous chemicals, ALWAYS refer to appropriate Material Data Safety Sheets (MSDS) and OSHA/GHS (Global Harmonized System of Classification and Labelling of Chemicals) guidelines for information on allowable personal exposure levels, proper respiratory protection, and handling instructions.

Refrigerant Oil

Observe the following precautions when working with or around refrigerant oil:

⚠ WARNING

Personal Protective Equipment (PPE) Required!

Protect your eyes from contact with refrigerant oil. The oil can cause serious eye injuries. Protect skin and clothing from prolonged or repeated contact with refrigerant oil. To prevent irritation, wash your hands and clothing thoroughly after handling the oil. Rubber gloves are recommended. When working with or around hazardous chemicals, ALWAYS refer to appropriate Material Data Safety Sheets (MSDS) and OSHA/GHS (Global Harmonized System of Classification and Labelling of Chemicals) guidelines for information on allowable personal exposure levels, proper respiratory protection, and handling instructions.

First Aid

REFRIGERANT

- **Eyes:** For contact with liquid, immediately flush eyes with large amounts of water and get prompt medical attention.
- **Skin:** Flush area with large amounts of warm water. Do not apply heat. Remove contaminated clothing and shoes. Wrap burns with dry, sterile, bulky dressing to protect from infection. Get prompt medical attention. Wash contaminated clothing before reuse.
- **Inhalation:** Move victim to fresh air and use Cardio Pulmonary Resuscitation (CPR) or mouth-to-mouth resuscitation to restore breathing, if necessary. Stay with victim until emergency personnel arrive.
- **Frost Bite:** In the event of frost bite, the objectives of First Aid are to protect the frozen area from further injury, warm the affected area rapidly, and to maintain respiration.

REFRIGERANT OIL

- **Eyes:** Immediately flush with large amounts of water for at least 15 minutes. Get prompt medical attention.
- **Skin:** Remove contaminated clothing. Wash thoroughly with soap and water. Get medical attention if irritation persists.

- **Inhalation:** Move victim to fresh air and use Cardio Pulmonary Resuscitation (CPR) or mouth-to-mouth resuscitation to restore breathing, if necessary. Stay with victim until emergency personnel arrive.
- **Ingestion:** Do not induce vomiting. Immediately contact local poison control center or physician.

ENGINE COOLANT

- **Eyes:** Immediately flush with large amounts of water for at least 15 minutes. Get prompt medical attention.
- **Skin:** Remove contaminated clothing. Wash thoroughly with soap and water. Get medical attention if irritation persists.
- **Ingestion:** Do not induce vomiting. Immediately contact local poison control center or physician.

BATTERY ACID

- **Eyes:** Immediately flush with large amounts of water for at least 15 minutes. Get prompt medical attention. Wash skin with soap and water.
- **Skin:** Immediately remove contaminated clothing. Wash skin with large volumes of water, for at least 15 minutes. Wash skin with soap and water. Do not apply fatty compounds. Seek immediate medical assistance.
- **Inhalation:** Provide fresh air. Rinse mouth and nose with water. Seek immediate medical assistance.
- **Ingestion:** If the injured person is fully conscious: make the person drink extensive amounts of milk. Do not induce vomiting. Take the injured person immediately to a hospital.

ELECTRICAL SHOCK

Take IMMEDIATE action after a person has received an electrical shock. Get quick medical assistance, if possible.

The source of the shock must be quickly stopped, by either shutting off the power or removing the victim. If the power cannot be shut off, the wire should be cut with a non-conductive tool, such as a wood-handle axe or thickly insulated cable cutters. Rescuers should wear insulated gloves and safety glasses, and avoid looking at wires being cut. The ensuing flash can cause burns and blindness.

If the victim must be removed from a live circuit, pull the victim away with a non-conductive material. Use wood, rope, a belt or coat to pull or push the victim away from the current. DO NOT TOUCH the victim. You will receive a shock from current flowing through the victim's body. After separating the

Safety Precautions

victim from power source, immediately check for signs of a pulse and respiration. If no pulse is present, start Cardio Pulmonary Resuscitation (CPR). If a pulse is present, respiration might be restored by using mouth-to-mouth resuscitation. Call for emergency medical assistance.

ASPHYXIATION

Move victim to fresh air and use Cardio Pulmonary Resuscitation (CPR) or mouth-to-mouth resuscitation to restore breathing, if necessary. Stay with victim until emergency personnel arrive.

Safety Decals and Locations

Condenser and Evaporator Fans

Be aware of the warning nameplates near the condenser fans and evaporator fans.

Figure 1. Fan Warning Nameplate



High Voltage Components

Various components on the Precedent S-750i unit operate using 460V/60Hz or 537V/70Hz high voltage and are identified by warning nameplates.

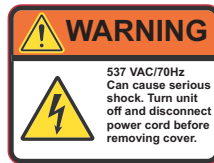
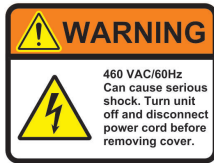

All high voltage wiring is identified by ORANGE conduit. Be aware of the locations of these components. Only certified, trained technicians can service them.

Figure 2. S-750i High Voltage Component Locations (Front)

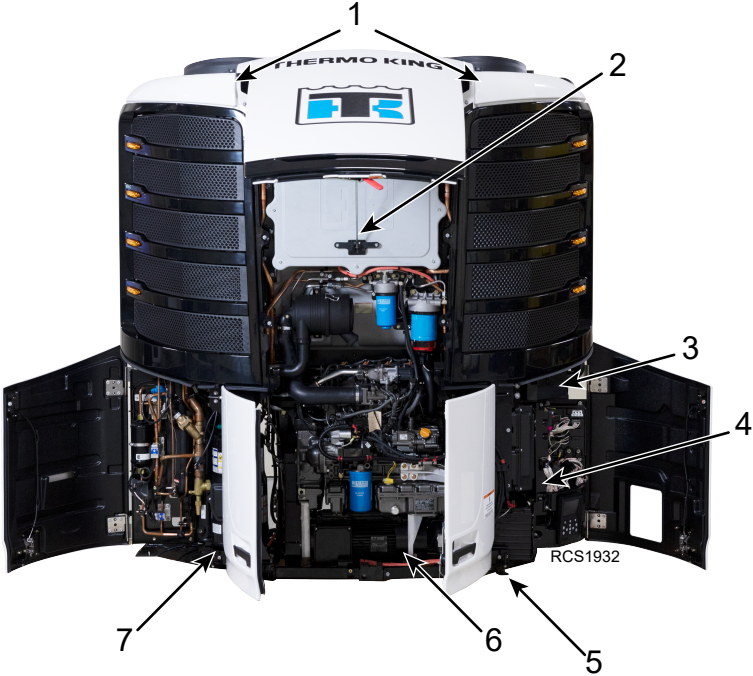

1.	Condenser Motors	5.	StandBy Power Receptacle (under unit)
2.	Evaporator Motor	6.	Electric Generator
3.	High Voltage Box	7.	Scroll Compressor
4.	High Voltage Contactor Box		

Figure 3. S-750i High Voltage Component Locations (Rear)

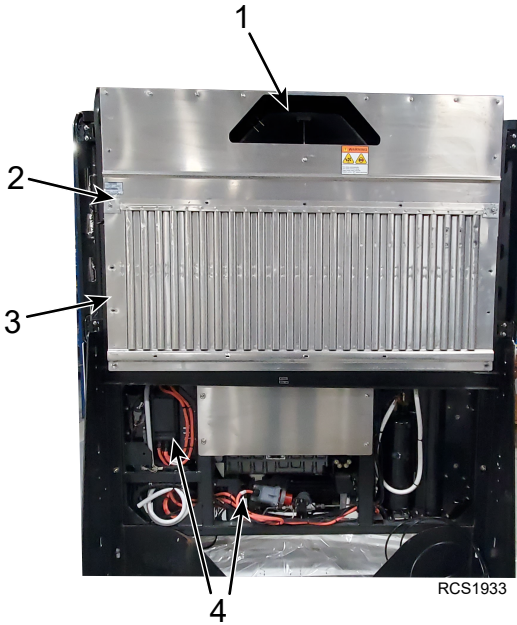

1.	Evaporator Motor	3.	Junction Box*
2.	Heater Strips*	4.	ORANGE conduit = HIGH VOLTAGE WIRING
* Located behind access panel.			

Figure 4. Ether Starting Aids Warning Nameplate (located near engine)



AMA1584

California Proposition 65 Warning Nameplate

Figure 5. P65 Warning Nameplate



RCS1032

Telematics

▲ WARNING

Risk of Injury!

Thermo King S-750i units are equipped with telematics 2 way communication system that includes the ability to start and stop the unit from a remote location via satellite or cellular phone. Once turned on, the unit can start and operate automatically at any time. Always turn the unit On/Off switch Off and disconnect the battery before doing inspections or working on any part of the unit.

Warning Remote Control Nameplate

A **Warning Remote Controlled Unit** nameplate is located next to the unit's lower door release.

Figure 6. Remote Control Warning Nameplate

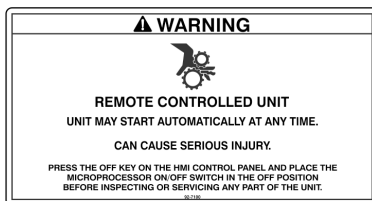

ARA1764

Unit Description

Unit Overview

The Thermo King Precedent S-750i is a one piece, self-contained, diesel powered, air cooling/heating unit designed for single temperature trailer applications. The unit mounts on the front of the trailer with the evaporator extending through an opening in the front wall. The hermetically sealed scroll compressor is used for cooling and the electric heater bars provide for heating and defrost. The compressor, electric fans and electric blowers are powered by an AC generator connected via a belt drive to a diesel engine, or from an external electric standby power source. See the following component features.

Figure 7. Front View of S-750i



Diesel Engine

The S-750i is powered by a quiet running, TK488CR1 common rail fuel injected, water cooled, four-cylinder, diesel engine. An electronic Engine Control Unit (ECU) monitors and controls all engine functions. The engine is equipped with an Exhaust Gas Recirculation System (EGR) and a Diesel

Oxidation Catalyst (DOC) exhaust treatment system and is EPA Tier 4 Compliant and CARB Evergreen. Refer to the Specifications section for additional engine information.

Extended Life Coolant (ELC)

ELC (Extended Life Coolant) is standard equipment. The maintenance interval for ELC is five years or 12,000 hours. A nameplate on the coolant expansion tank identifies units with ELC. The new engine coolant, Chevron Extended Life Coolant, is RED in color instead of the previous GREEN or BLUE-GREEN colored conventional coolants.

NOTICE

System Contamination!

Do not add "GREEN" or "BLUE-GREEN" conventional coolant to cooling systems using "RED" Extended Life Coolant, except in an emergency. If conventional coolant is added to Extended Life Coolant, the coolant must be changed after 2 years instead of 5 years.

Note: *The use of 50/50 percent pre-mixed Extended Life Coolant (ELC) is recommended to assure that de-ionized water is being used. If 100 percent full strength concentrate is used, de-ionized or distilled water is recommended over tap water to insure the integrity of the cooling system is maintained.*

EMI 3000

EMI 3000 is an extended maintenance interval package. The EMI 3000 package consists of the following key components:

- EMI 3000-Hour Cyclonic Air Cleaner Assembly and Air Cleaner Element
- EMI 3000-Hour 5-Micron Fuel Filter
- EMI 3000-Hour Dual Element Oil Filter (blue with white lettering)
- API Rating CJ-4 or CK-4 Oil
- Five Year or 12,000 Hour Extended Life Coolant (ELC)

The EMI package allows standard maintenance intervals to be extended to 3,000 hours, or 2 years, whichever occurs first.

Note: *Units equipped with the EMI 3000 package do require regular inspection in accordance with Thermo King's maintenance recommendations.*

Unit Description

Scroll Compressor

The unit is equipped with a Thermo King electric TKSR151 Hermetic Scroll Compressor.

Electronic Throttling Valve (ETV)

The Electronic Throttling Valve (ETV) is a variable position valve controlled by the microprocessor. The ETV provides enhanced control of the refrigeration system.

Solar Panel

The Precedent S-750i is equipped with a 30 watt solar panel located on top of the unit. The panel is connected directly to the unit's 12 volt battery to help maintain battery voltage when the unit is not in operation. The panel is equipped with a charge controller to prevent overcharging the battery.

Note: *For optimum performance, the panel should be routinely cleaned and kept free of dirt, debris or other obstructions.*

Telematics

This trailer unit is equipped with TracKing ConnectedSuite™ communication device that when enabled allows remote access to unit data. Contact your Thermo King representative for more information about all the features and options available with TracKing ConnectedSuite. Downloading TK Connect mobile app will allow you to monitor and manage temperature and reefer settings over the road, in the yard or in-cab via Bluetooth®.

Control System

⚠ WARNING

Risk of Injury!

The unit can start at any time without warning. Press the OFF key on the HMI control panel and place the Service Switch in the Off position before inspecting or servicing any part of the unit.

Note: *The Unit Service Switch must be in the ON position for the unit to operate.*

The Precedent S-750i Control System consists of a Main Application Controller (MAC) and Human Machine Interface (HMI) control panel. The MAC and HMI are combined in one control device known as the Controller. The HMI is used to operate the unit and is visible through an opening in the lower roadside service door. The user can access the following menus to interact with the unit:

- Power Up and Power Down Unit
- Display and Change Language
- Display and Change Temperature Setpoint
- Display and Initiate Defrost
- Display System Status of Engine, Refrigeration, Power and Controls
- Display and Clear Alarms

See Operating Instructions for more information about the Controller.

Figure 8. HMI Shown



RCS1847

Unit Description

Operating Modes

The unit can be operated in the following modes:

- Diesel Mode
- Electric Mode

Diesel Operation

In diesel operation, the controller will select the operating mode from the following:

- Cool (3 speeds, High, Medium, or Low Engine RPM)
- Heat (3 speeds, High, Medium, or Low Engine RPM)
- Null (CYCLE-SENTRY operation only)
- Defrost

Electric Operation

In electric operation, the controller will select the operating mode from the following:

- Cool
- Electric Heat
- Null (CYCLE-SENTRY operation only)
- Electric Defrost

Defrost

Frost gradually builds-up on evaporator coils as a result of normal operation. The unit uses electric heater bars mounted on the evaporator coil to defrost the evaporator coils to melt the frost. The water flows through collection drain tubes onto the ground. The methods of Defrost initiation are Automatic and Manual

Automatic Defrost: The controller is programmed to automatically initiate timed or demand defrost cycles. The controller can also be programmed to initiate timed defrost cycles at intervals of 2, 4, 6, 8, or 12 hours. Demand defrost cycles occur if the differences between the return air temperature, discharge air temperature, and coil temperature exceed certain limits. The unit can enter defrost cycles as often as every 30 minutes if required.

Manual Defrost: In Manual Defrost Mode, the operator initiates a defrost cycle. See "Initiating a Manual Defrost Cycle".

Note: *The unit will not perform a Manual Defrost cycle unless the unit has been turned on with the ON key, the unit is running in Continuous or CYCLE-SENTRY mode (or shut down in CYCLE-SENTRY Null mode), and the coil temperature is below 45 F (7 C).*

The evaporator coil temperature must be below 45 F (7 C) to allow defrost.

The following four defrost timers are used. These timers can be set for intervals of 2, 4, 6, 8 or 12 hours.

- Defrost Interval In Range with Fresh Setpoint (standard setting 6 hours)
- Defrost Interval Not In Range with Fresh Setpoint (standard setting 4 hours)
- Defrost Interval In Range with Frozen Setpoint (standard setting 6 hours)
- Defrost Interval Not In Range with Frozen Setpoint (standard setting is 6 hours)

This feature allows a shorter Defrost interval to be used when the unit is out of range during a pull-down and more frequent Defrost cycles may be beneficial.

Normally, longer defrost timer intervals are used for colder loads. The defrost interval may need to be changed if the unit will not hold the compartment temperature at setpoint.

Use a longer defrost interval if defrost is not being initiated on demand.

Use a shorter defrost interval if defrost is frequently being initiated on demand.

If the unit is in CYCLE-SENTRY Null mode, the engine will start when defrost is initiated. The unit will stay in defrost until the evaporator coil temperature rises to 50 F (10 C).

Service Switch

WARNING

Risk of Injury!

The unit can start at any time without warning. Press the OFF key on the HMI control panel and place the Service Switch (Main On/Off switch) in the Off position before inspecting or servicing any part of the unit.

Placing the Service Switch in the OFF position prevents the unit from starting. The switch should be put into the OFF position when checking engine oil, belt tensions, etc. The switch is located behind the lower roadside body panel surrounding the controller. Open the body panel to access the switch.

Figure 9. Service Switch Shown



RCS1849-1

CYCLE-SENTRY™ Start-Stop Controls

The CYCLE-SENTRY Start-Stop fuel saving system provides optimum operating economy.

⚠ WARNING

Risk of Injury!

The unit can start at any time without warning. Press the OFF key on the HMI control panel, place the unit Service Switch (On/Off switch) in the Off position, and disconnect the battery before inspecting or servicing any part of the unit.

When CYCLE-SENTRY Mode is selected, the unit will start and stop automatically to maintain setpoint, keep the engine warm, and the battery charged. When Continuous Mode is selected, the unit starts automatically and runs continuously to maintain setpoint and provide constant airflow.

Features of the CYCLE-SENTRY system are:

- Offers either CYCLE-SENTRY or Continuous Run operation.
- Controller regulated all season temperature control.
- Maintains minimum engine temperature in low ambient conditions.
- Battery Sentry keeps batteries fully charged during unit operation.
- Variable preheat time.
- Preheat indicator buzzer.

Communication Ports

A Universal Serial Bus (USB) port is located close to the HMI panel of the unit and can be accessed from below. If a USB Flash Drive is connected to the USB connector, the menu item allows the user to select the desired Flash Drive function.

It is important that the USB is formatted to FAT or FAT32 (the unit does not accept NTFS and exFAT format).

Using a properly configured USB flash drive, the following functions may be available:

- Download the Service Log Data Logger (csv.gz format file)
- Download the Compliance Log Data Logger (PDF file)
- Flash load the controller software (Refer to)

Opening the Front Doors

To open the doors and access the engine compartment:

1. Pull the right door latch handle out at a 45 degree angle
2. Turn it down (clockwise) 90 degrees.

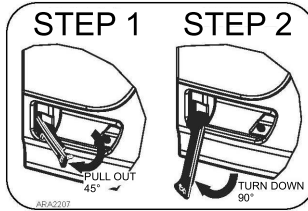

Close the doors in reverse order.

Figure 10. Door Latch Location



Engine Compartment Components

⚠ WARNING

Risk of Injury!

The unit can start at any time without warning. Press the OFF key on the HMI control panel, place the unit Service Switch (On/Off switch) in the Off position, and disconnect the battery before inspecting or servicing any part of the unit.

⚠ CAUTION

Service Procedures!

Turn the unit off before attempting to check the engine oil.

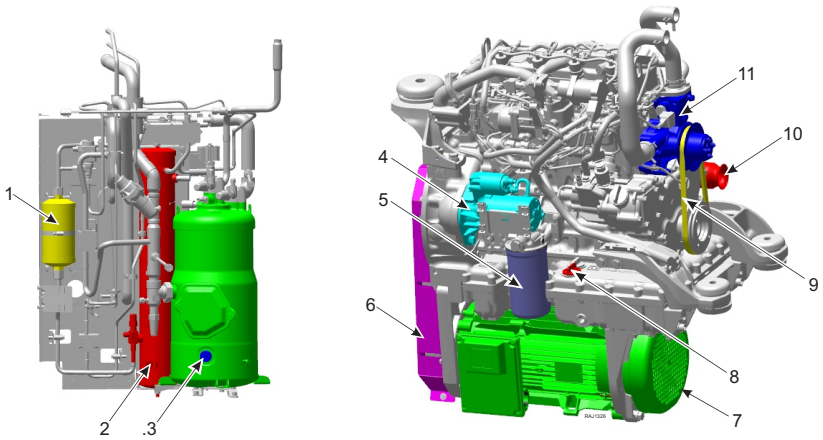

1.	Filter / Dryer	7.	Generator
2.	Receiver Tank Sight Glass	8.	Oil Level Dipstick
3.	Compressor Sight Glass	9.	Water Pump Belt
4.	Engine Starter Motor	10.	DOC Exhaust Outlet
5.	Engine Oil Filter	11.	Water Pump
6.	Generator Belt Drive		

Unit Protection and Control Devices

Fuses and Electrical

Main Fuse Block

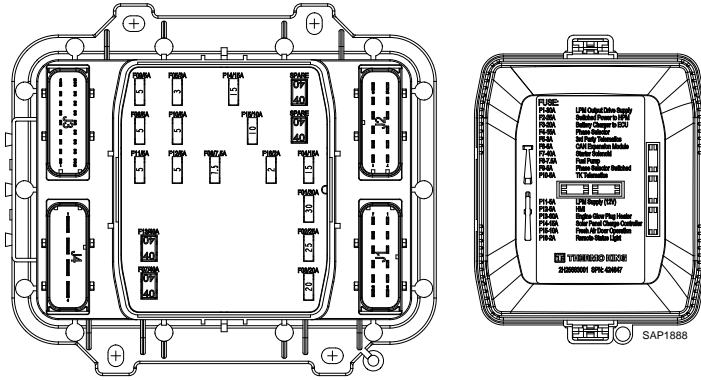

Fuse	Size	Function	Fuse	Size	Function
F1	30A	LPM Output Drive Supply	F9	5A	Phase Selector Switched
F2	25A	Switched Power to HPM	F10	5A	TK Telematics
F3	20A	Battery Charger to ECU	F11	5A	LPM Supply (12V)
F4	15A	Phase Selector	F12	5A	HMI
F5	3A	3rd Party Telematics	F13	40A	Engine Glow Plug Heater
F6	5A	CAN Expansion Module	F14	15A	Solar Panel Charge Controller
F7	40A	Starter Solenoid	F15	10A	Fresh Air Door Operation
F8	7.5A	Fuel Pump	F16	2A	Remote Status Light

Important: F7 and F13 are slow blow style fuses. ONLY replace S-750i fuses with parts supplied from Thermo King.

Fuseblock Assembly (2A)

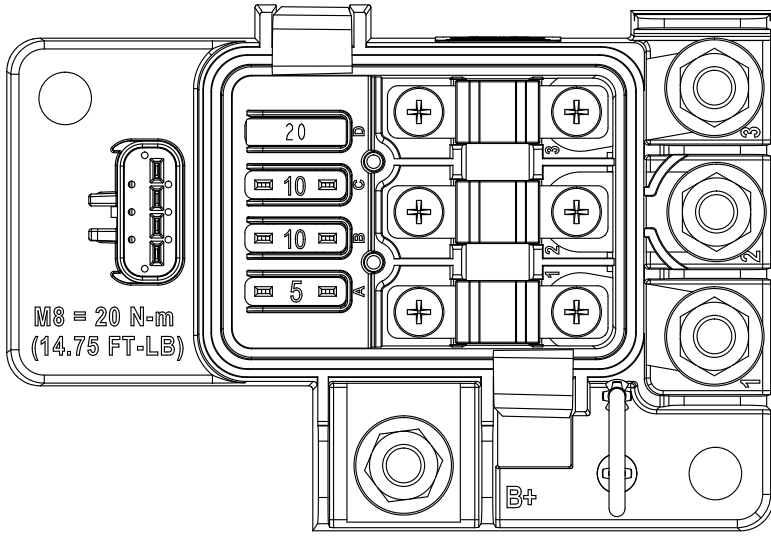

Fuse	Size	Function
Fuse D	20A	Fuel Heater
Fuse C	10A	Rear Remote Controller/Printer
Fuse B	10A	Exhaust Gas Recirculation Valve
Fuse A	5A	Independent Data Logger
Fuse 3	40A	Battery Charger
Fuse 2	40A	Spare2
Fuse 1	23A	Spare1

Unit Protection and Control Devices

High Voltage Distribution Box

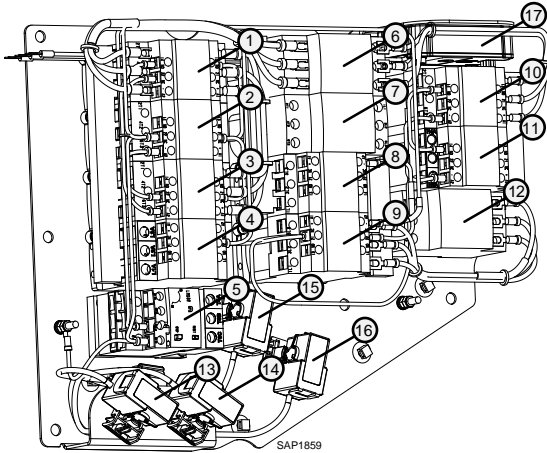

Fuse	Function	Fuse	Function
1	Phase Contactor #2	10	Heater Contactor #1
2	Generator Contactor #1	11	Heater Contactor #2
3	Phase Contactor #1	12	Battery Charger Fuse Block (12A, 3 Fuses)
4	Compressor Contactor	13	Current Transformer 1 (Compressor Motor Current)
5	Generator Overload Relay - GCI (29A)	14	Current Transformer 2 (Compressor Motor Current)
6	Heaters Fuse Block (15A, 3 Fuses)	15	Current Transformer 3 (System Current)
7	Fan Box Fuse Block (7A, 3 Fuses)	16	Current Transformer 4 (System Current)
8	Battery Charger Electric Contactor	17	Phase Select Module
9	Generator Contactor #2		

HMI Control Panel

⚠ CAUTION

Risk of Injury!

Do not operate the HMI Control Panel until you are completely familiar with its function.

The Human/Machine Interface (HMI) Control Panel is integrated into the Controller and is used to operate the unit and display unit information. The HMI/MAC communicates with the Low Power Module (LPM) and High Power Module (HPM) via a controller area network (CAN) bus. The HMI Control Panel consists of a display and 12 touch-sensitive keys. The display is capable of showing both text and graphics. The HMI Control Panel also contains the Temperature Log data logger.

Figure 11. HMI Control Panel Details

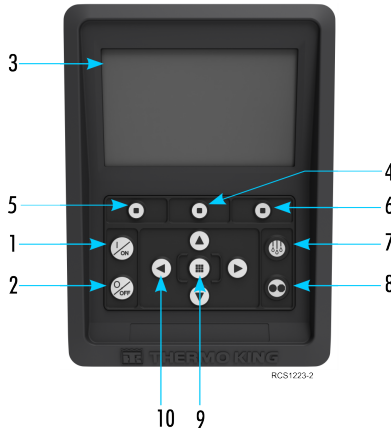

Keypad Details			
1.	On Key	6.	Soft Key 3
2.	Off Key	7.	Defrost Key
3.	Display Screen (5.7")	8.	Cycle-Sentry Key
4.	Soft Key 2	9.	Accept/Enter Key
5.	Soft Key 1	10.	Navigation Keys (x4)

Hard Keys

There are four hard keys with dedicated functions.



ON Key: Used to turn the unit on.



Off Key: Used to turn the unit off.



Defrost Key: Press this key to initiate a Manual Defrost cycle.



CYCLE SENTRY Key: Used to select Cycle Sentry Mode or Continuous Mode operation if allowed by OptiSet Plus.

Soft Keys

There are three soft keys. The function of soft keys change depending on the operation being performed.

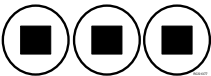

SOFT Keys: The three keys directly under the display are soft keys. The function of soft keys change depending on the operation being performed. If a soft key is active, its function will be shown in the display directly above the key.

Navigation Keys

There are four navigation keys that allow the operator to scroll up, down, left and right to view or make changes to a selected display.



UP Key: Used to scroll up through the display menu.



DOWN Key: Used to scroll down through the display menu.



LEFT Key: Used to scroll to the left of the display menu.



RIGHT Key: Used to scroll to the right of the display menu.

Accept/Enter Key

The center key is used to accept changes. It is also used to enter changes made by the operator.



ACCEPT/ENTER Key: Used to accept or enter changes.

Operation

Standard Display

The Standard Display is the “base” from which all other display operations are launched. The Standard Display appears after the unit startup sequence is completed.

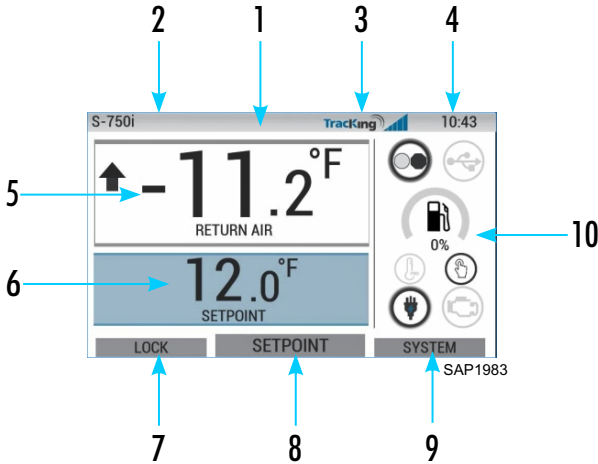

Standard Display and Icon Descriptions	
1.	Status Bar — Displays unit information across top of screen.
2.	Model Type/Specification — Displays unit type.
3.	TracKing Signal — Displays telematics signal strength.
4.	Time w/Time Zone — Displays current time. Time Zone shows that you are now in a region +/- from the time shown.
5.	Trailer Temp — Displays actual box temperature and the user-configured controlling sensor. Default controlling sensor is Return Air.
6.	Setpoint — Displays temperature defined by user.
7.	LOCK — Is customizable in Main Menu Plus (Default screen is LOCK).
8.	SETPOINT — Used for critical functions.
9.	SYSTEM — Is customizable in Main Menu Plus.
10.	DASHBOARD - See Dashboard Section for details. (“Dashboard,” p. 36)

TemperatureWatch™ Display

The Standard Display defaults to the TemperatureWatch Display after about three minutes of non-use (when no keys are pressed) and no info, check or shutdown alarms are present. The Lock Symbol in the Display Dashboard signifies that the Display is locked.

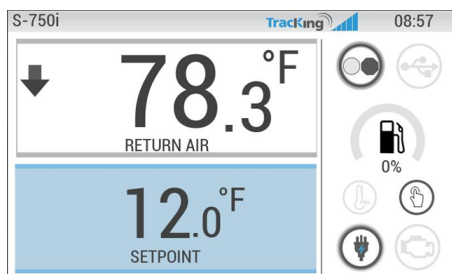

1. Press any key to enter the Unlock System Screen.

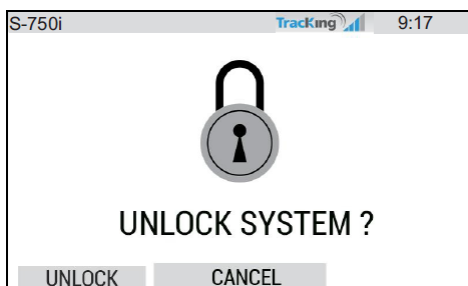

2. Verify by selecting "Unlock" at this screen.
3. You will then be returned to the Standard Display.

Dashboard

The Dashboard is located on the right of the Standard Display and is the hub for overall system operation. Similar to a car dashboard, all icons have a defined position and only become lit when active. This allows the operator to quickly identify the unit’s operating mode e.g., Continuous, Cycle-Sentry, Diesel or Electric.

Figure 12. Standard Display with Dashboard on Right Shown

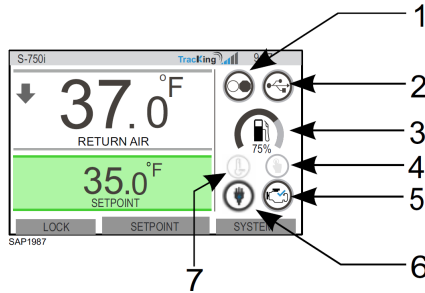

Dashboard Icons and Descriptions	
1.	Cycle-Sentry: This icon indicates the unit is operating in Cycle-Sentry mode when illuminated. When not illuminated, the unit is operating in Continuous mode.
2.	USB Connection Status: This icon indicates a USB flash drive is connected to the Controller when illuminated. When not illuminated, the USB flash drive is not connected/detected.
3.	Fuel Level: This icon indicates the trailer unit’s fuel in percentage (if applicable).
4.	<p>Auto- Switch: This icon indicates:</p> <ul style="list-style-type: none"> When illuminated, Auto-Switch Enabled feature is set to ENABLE, allowing unit to switch automatically from Diesel Mode to Electric Mode when standby power is connected and available. Not illuminated, Auto-Switch Enabled feature is set to DISABLE, keeping unit in Diesel Mode. A prompt screen (Yes/No) will appear when standby power is connected and available.
5.	Diesel Operation: This icon indicates the unit is operating in Diesel Mode.
6.	Electric Operation: This icon indicates the unit is operating in Electric Mode (if applicable).
7.	OptiSet PRO: When an OptSet profile is uploaded on a unit, this icon will be illuminated.

Alarms

Info Log

Info Log events serve as a notice to take corrective action before a problem becomes severe. Maintenance items such as maintenance hourmeter time-outs are Info Log events. The TemperatureWatch screen is not disabled if only Info Log event(s) are active.

When the unit is turned on, the display will show the Thermo King Logo and then the "Configuring System" message. The Info Log event notification will appear on the Standard Display.

An Info Log event is indicated by an "information" notification on the display located next to the setpoint. The Info Log event icon will appear.

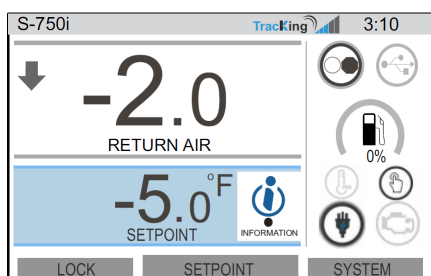

Check Alarm

A Check alarm is indicated by a "check alarm" notification on the display located next to the setpoint. The Check alarm icon will appear. This level of alarm serves as a notice to take corrective action before a problem becomes severe. The unit will run with Check alarms but some features and functions may be inhibited. If a Check alarm condition occurs while the unit is running, the alarm icon will appear in the display.

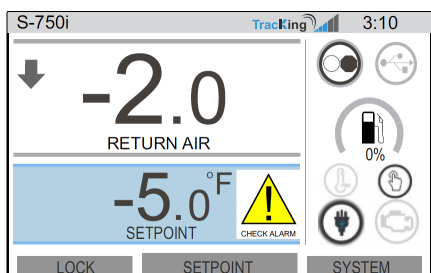

Prevent Shutdown Alarm

A Prevent Shutdown alarm is indicated by an "Alarm Active" enlarged red icon in the center of the display. The Alarm Active icon will appear. The unit will be temporarily shut down if a Prevent alarm is active. The unit will remain shut down for a timed restart interval or until the fault conditions are corrected and then restart. In some cases, the unit will restart with reduced performance to determine if continued operation is possible. If the alarm does not reoccur with reduced performance, the unit will return to full performance. In general, if the alarm condition reoccurs a defined number of times, the alarm is set as a Shutdown alarm and no further restarts are possible.

Note: *If the Restart After Shutdown feature in the Guarded Access Menu is set as DISABLED, the control system will regard all prevent shutdown alarms as standard shutdown alarms.*

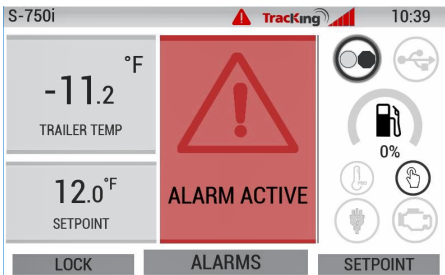

Shutdown Alarm

A Shutdown alarm is indicated by an "Alarm Active" enlarged red icon in the center of the display. If a Shutdown alarm occurs while the unit is running, it will be indicated by all of the following:

- The Alarm Active icon will appear.
- The optional remote alarm light will flash on and off.

Shutdown alarms will force the unit into shutdown. The unit will remain in shutdown until the Shutdown alarm is manually cleared. Exceptions are some engine and electric Shutdown alarms that become Info Log events when switched to the alternate operating mode (diesel to electric or electric to diesel).

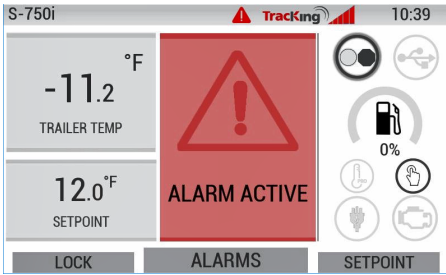

Turning Unit On

Note: The Service Switch must be in the “ON” position for the unit to operate.

Turn Unit On:

Turn the unit on by pressing the ON Key. Diesel engine preheats and starts are automatic in both Continuous Mode and Cycle Sentry Mode. The engine preheat and start will be delayed in Cycle Sentry mode if there is no current need for the engine to run.

Notes:

1. System startup sequence may take up to 60 seconds.
2. If Electric Standby is active, there may be some additional prompts before the engine/electric mode will start.



Once the system startup sequence is completed, the Standard Display will appear and the unit will start in Diesel Mode (if no Electric Standby is detected). The temperature setpoint or other system changes can now be made if required.

Note: *Operating Mode: The unit retains the last user configured operating mode when power cycled. i.e., if the unit was running in Continuous Mode, and power is cycled, the unit would still remain in continuous mode.*

Turning Unit Off

Turn the unit off by pressing the OFF Key. When the off key is pressed, the display will briefly show "SYSTEM IS POWERING DOWN". After the power-down sequence is complete the display will be blank.

Note: When the unit is turned off using the HMI Controller, no temperature control is available. If the unit is not going to be operated for one week or longer, placing the Service Switch in the OFF position will help prevent parasitic battery voltage loss and a dead unit battery.

Figure 13. System Powering Down Sequence Shown

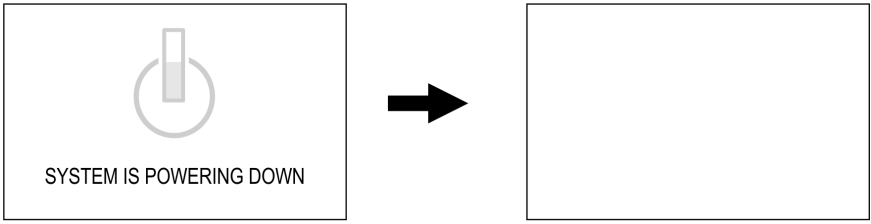

RCS1393

Changing the Setpoint

- Pressing Soft Key 2 under SETPOINT will take you to the setpoint screen.



- Pressing the UP arrow key will increase the value by 1 until setpoint reaches to higher limit.

Operation

- Pressing the DOWN arrow key will decrease the value by 1 until setpoint reaches lower limit.
- Pressing and holding either the UP or DOWN arrow key will accelerate the values until released.
- Pressing Soft Key 3 under CONFIRM will display “PROGRAMMING SETPOINT PLEASE WAIT”.
- If change is successful – HMI will display “SETPOINT CHANGED”.
- If change is unsuccessful – HMI will display “SETPOINT NOT CHANGED”.



Defrost

The requested operating mode is indicated by the arrow next to the Return Air Temperature. A downwards pointing arrow indicates the unit is operating in Cool Mode. An upwards pointing arrow indicates the unit is operating in Heat Mode. The evaporator coil symbol instead of the return air temperature indicates the unit is operating in Defrost Mode. Refer to figures below.

Defrost cycles are usually initiated automatically based on time and demand. The operator can also initiate a manual defrost if necessary. Manual defrost

is only available while in temperature control and the evaporator coil temperature is less than or equal to 45°F (7°C).

Note: Other features such as door switch settings may not allow manual defrost under certain conditions.

- If the defrost parameters are met, the HMI will display “PROGRAMMING DEFROST” followed by “UNIT IS DEFROSTING”.
- In Defrost Mode, the trailer box temperature will be replaced by defrost information.
- Additionally, the return air temperature (trailer temp) will be replaced by the coil icon and an intermediate spinner on top with a display progress bar for the remaining defrost time across the bottom.



SAP1994

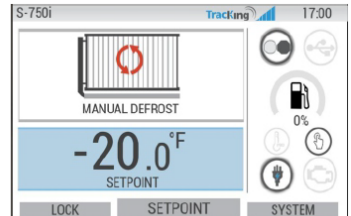

SAP1995

When the defrost is complete, the HMI will display “EXITING DEFROST” for two seconds and return to the standard display.

Operation

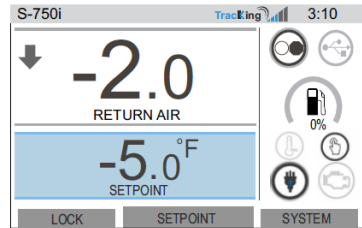
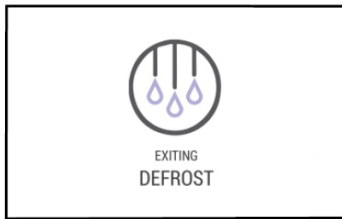

HMI will display “DEFROST NOT AVAILABLE” if the defrost parameters are not met.

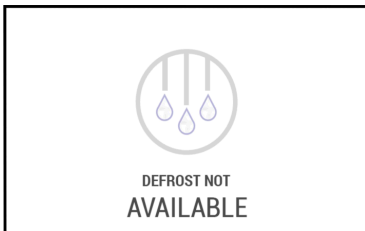

RCS1403

Fresh/Frozen Range

The Fresh/Frozen Range is fixed at 14°F. When the setpoint is selected to 14°F or above, the setpoint panel will change to a Green color which defines the trailer temperature zone as “Fresh”. When the setpoint is selected to 13°F or below, the setpoint panel will change to a Blue color which defines the trailer temperature zone as “Frozen”.

Starting Diesel Engine

▲ CAUTION

Risk of Injury!

The engine may start automatically any time the unit is turned on.

NOTICE

Equipment Damage!

Never use starting fluid. Damage to the engine can occur.

The diesel engine preheats and starts automatically in both Continuous Mode and CYCLE-SENTRY mode. The engine will preheat and start if

necessary when the unit is turned on. The engine preheat and start will be delayed in CYCLE-SENTRY mode if there is no current need for the engine to run. If a key or sequence of keys are pressed on the HMI Control Panel before the engine starts, the engine will preheat and start approximately 10 seconds after pressing the last key.

Note: Run a pretrip test if the unit has not been used recently. Refer to (*"Pretrip Menu," p. 65*).

Starting Electric Mode

▲ CAUTION

Risk of Injury!

The motor may start automatically any time the unit is turned on.

Electric mode starting is automatic in both Continuous mode and Cycle Sentry mode. The electric components will start as required when the unit is turned on. If any keys are being pressed on the HMI Control Panel prior to electric start, the electric start will be delayed until 10 seconds after the last key is pressed.

When electric mode is preparing to start, the HMI Control Panel will display the electric mode start screen. The buzzer sounds for 10 seconds before electric mode starts.

After electric mode is started, the display returns to the Standard Display of temperature and setpoint.

Switching From Diesel To Electric

If the Auto-Switch from Diesel to Electric Enabled feature in Guarded Access is set ENABLE, the unit will automatically switch to Electric Operation when standby power is connected and available. If the Auto-Switch from Diesel to Electric Enabled feature in Guarded Access is set DISABLE, the prompt screen will appear when standby power is connected and available.

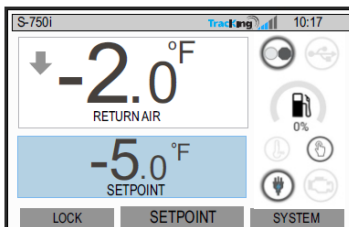

SAP1997

Electric Operation will briefly be confirmed.



Switching From Electric To Diesel

If the Auto-Switch from Electric to Diesel Enabled feature in Guarded Access is set to ENABLE, the unit will automatically switch to Diesel Operation when standby power is turned off or is no longer available. If the Auto-Switch from Electric to Diesel Enabled feature in Guarded Access is set to DISABLE and standby power is disconnected or fails, the unit will not automatically switch to Diesel Operation. This is primarily designed to prevent unauthorized diesel engine starts where engine operation is strictly prohibited.

If the Auto-Switch from Electric to Diesel Enabled feature in Guarded Access is set to DISABLE, the unit can be switched from Electric Operation to Diesel Operation using the Diesel Selection from the Main Menu.

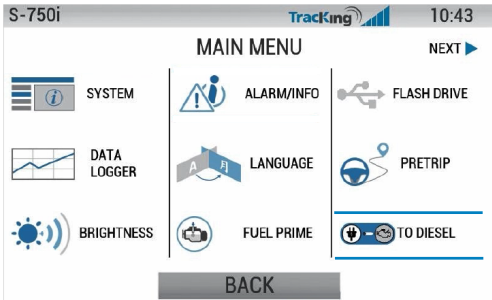

SAP1998

Diesel Operation will briefly be confirmed.

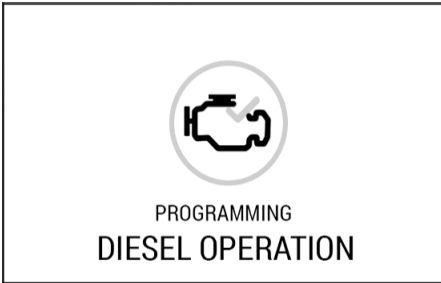

RCS1255

Selecting Cycle Sentry/Continuous

When Cycle-Sentry is selected, the unit will start and stop automatically to maintain setpoint, keep the engine warm, and the battery charged. When Continuous is selected, the unit starts automatically and runs continuously to maintain setpoint and provide constant airflow. If the unit is operating in Cycle-Sentry, the Cycle-Sentry icon will be illuminated. If the Cycle-Sentry icon is not illuminated, the unit is operating in Continuous.

Important: *Cycle-Sentry or Continuous may not be selectable if OptiSet Profile is in use.*

Initiating Cycle-Sentry



SAP1999

Cycle-Sentry Operation



SAP2000

Temperature Datalogger

The temperature datalogger is physically located within the Main Application Controller (MAC). It can support up to eight optional temperature sensors.

Main Menu

The Main Menu contains several additional menus that allow the user to view information and modify unit operation. To access the Main Menu, press the ACCEPT/ENTER center key. Use the UP, DOWN, LEFT, or RIGHT navigation keys to scroll through the menu choices. When the desired selection is shown, press the ACCEPT/ENTER center key. Once selection is made, use the UP or DOWN navigation keys and the ACCEPT/ENTER center key to view information or modify unit operation. When finished, navigate to the BACK icon and press the ACCEPT/ENTER center key to return to the Standard Display.

Figure 14. Standard Display and Main Menu Display



SAP2001

System Menu

The System menu allows the user to view system information. From the Standard Display, press the ACCEPT/ENTER center key. To access the System menu, use the UP, DOWN, LEFT, or RIGHT keys. When System is shown as selected, press the ACCEPT/ENTER center key.

Operation

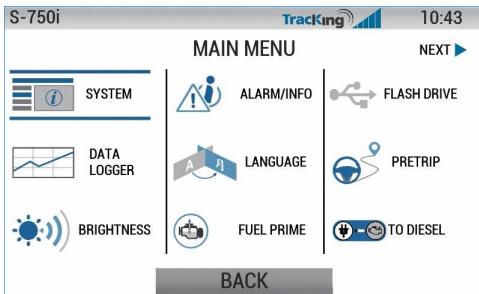

The basic system information will be displayed on the System submenu. This is information deemed critical/important to the user. Press the UP and DOWN keys to scroll through the system information. Selecting the LOCK key will lock the current system information on the display. Selecting the LEGAL key will display the Legal Disclaimer QR Code.

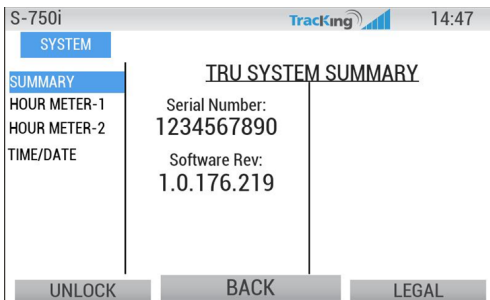

The system information that is available is shown below. Not all system information may appear depending on unit configuration, software revision, and HMI user level. To access more detailed technical system information, it is necessary to select the System menu option in Main Menu + HMI user level.

Summary	Displays system summary information of the trailer reefer unit (TRU). Includes Unit Serial Number and Software Revision.
Hourmeter-1	Allows the user to view the unit hourmeters. Includes Engine Run, Electric Mode Run, Total Compressor Run, and Controller On Hourmeters.

Hourmeter-2	Allows the user to view the unit hourmeters. Includes Total Temperature Control Hours, Diesel Mode Compressor Run Hours, Electric Mode Compressor Run Hours, Diesel Mode Temperature Protection Hours, and Electric Mode Temperature Protection Hours.
Time/Date	Allows the user to view the unit time and date. The time and date cannot be changed from this menu.

Hourmeter

Hourmeter allows the user to view the unit hourmeters. If the view feature for a particular hourmeter is not enabled, that hourmeter will continue to accumulate time but cannot be viewed from the Main Menu (System menu). However, all hourmeters can be viewed from Main Menu + and Guarded Access. From the Standard Display, press the ACCEPT/ENTER center key. From the Main Menu screen select System and press the ACCEPT/ENTER center key.

S-750i TracKing 09:55

SYSTEM

SUMMARY

HOUR METERS SUMMARY-1

Engine Run:	1	Electric Mode Run:	63
Total Compressor Run:	0	Controller On:	63

LOCK BACK LEGAL

S-750i TracKing 09:55

SYSTEM

SUMMARY

HOUR METER SUMMARY-2

Total Temp Control Hours:	2	Diesel Comp Run Hours:	1
Diesel Temp Protect Hrs:	1	Electric Comp Run Hours:	1
Electric Temp Protect Hrs:	1		

LOCK BACK LEGAL

Hourmeter names and definitions are shown in the table below.

Operation

Table 1. Hourmeter Names and Definitions

Engine Run Hours	Total number of hours the unit has run in diesel mode.
Electric Mode Hours	Total number of hours the unit has run in electric mode.
Total Compressor Run Hours	Total number of hours the scroll compressor has run in both diesel and electric mode.
Controller On Hours	Total number of hours the control system is powered on.
Total Temp Control Hours	Total number of hours the system has been powered on in both diesel and electric mode while controlling temperature.
Diesel Comp Run Hours	Total number of hours the scroll compressor has run in diesel mode.
Diesel Temp Protect Hours	Total number of hours the system has been powered on in diesel mode while controlling temperature.
Electric Comp Run Hours	Total number of hours the scroll compressor has run in electric mode.
Electric Temp Protect Hours	Total number of hours the system has been powered on in electric mode while controlling temperature.

Engine Submenu

The Engine submenu displays the following information.

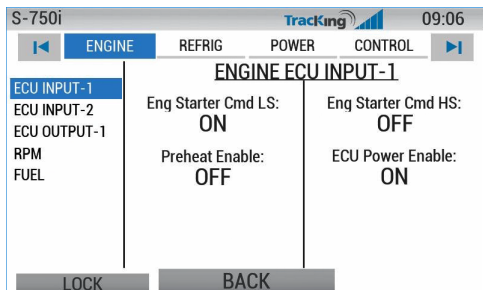

ECU Input-1: Displays the current state of the following inputs: Engine Starter Command Low Side and High Side, Preheat Enable, ECU Power Enable.

ECU Input-2: Displays the current state of the following inputs: Coolant Level, Engine Coolant Temperature, Engine Oil Pressure State, Engine Oil Level State.

ECU Output-1: Displays the current state of the following outputs: ECU Run Enable, ECU Enable, ECU Start Request, Eng Start Solenoid, Diesel Engine Preheat.

RPM: Displays Engine RPM, Engine Requested Speed RPM, Engine Load.

Fuel: Displays Electric Fuel Pump Status.

Operation

Refrigeration Submenu

The Refrigeration submenu displays the following information.

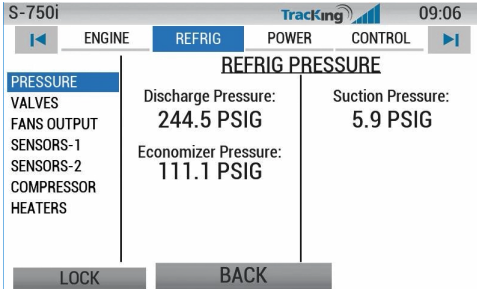

Pressure: Displays the Compressor Discharge Pressure, Compressor Suction Pressure, Economizer Pressure.

Valves: Displays ETV Position, ETV Enable, Economizer, Valve Enable, Econ Bypass Valve State, LIV Duty Cycle, HGBV Duty Cycle.

Fans Output: Displays Roadside Condenser Fan Motor, Curbside Condenser Fan Motor, Evaporator Low Speed Fan Motor, Evaporator High Speed Fan Motor.

Sensors-1: Displays current Return Control/Display, Discharge Control/Display, Evaporator Coil, Ambient Temperature.

Sensors-2: Displays current Spare Temperature, Temperature Differential (Return Air - Discharge Air), Scroll Compressor Refrigeration Discharge Temperature.

Compressor: Displays Compressor State and Compressor Enable.

Heaters: Displays Electric Heater 1 State, Electric Heater 2 State, Heater 1 Duty Cycle, Heater 2 Duty Cycle.

Power Submenu

The Power submenu displays the following information.

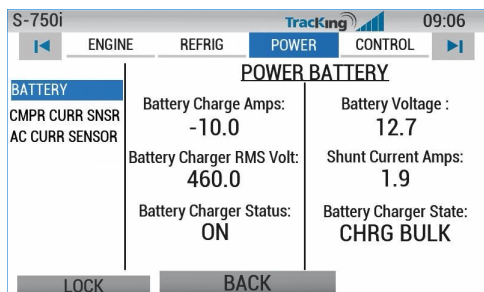

Battery: Displays Battery Charge Amps (Amps flowing to or from the unit battery), Battery Voltage, Battery Charger Input Voltage (RMS Volts), Shunt Current (Amps consumed by control system), Battery Charger Status, Battery Charger State.

Compressor Current Sensor: Displays Motor Phase 1 RMS Current, Motor Phase 2 RMS Current, Motor Phase 3 RMS Current, Motor Phase Pair Average Frequency.

AC Current Sensor: Displays System Phase 1 RMS Current, System Phase 2 RMS Current, System Phase 3 RMS Current, System Phase Pair Average Frequency.

Control Submenu

The Control submenu displays the following information.

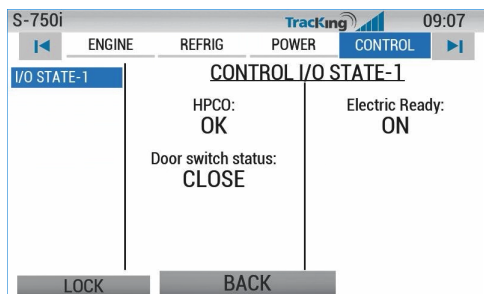

I/O State-1: Displays information for High Pressure Cutout (HPCO), Electric Ready Input, Door Switch Status.

Telematics Submenu

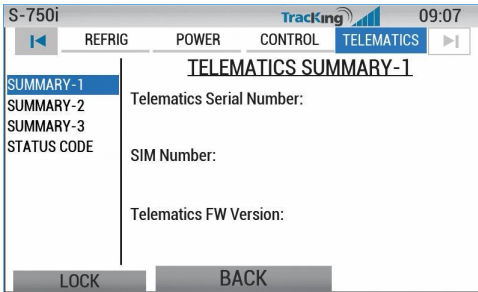

Summary-1: Displays Telematics Serial Number, SIM Number, and Telematics FW Version.
Summary-2: Displays Telematics Mode, GSM Registration Status, and GPRS/Data Registration Status.
Summary-3: Displays GPRS/Data Attach Status.
Status Code: Displays Telematic status fault codes (if available/active).

Alarm Information Menu

Alarms are displayed and cleared using the Alarm/Info menu. From the Standard Display, press the ACCEPT/ENTER center key. From the Main Menu screen select Alarm/Info and press the ACCEPT/ENTER center key.

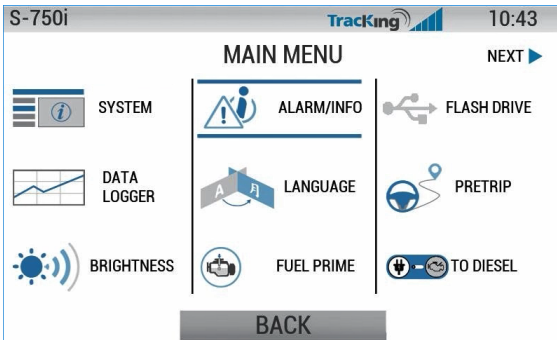

The Alarms display will appear. If no alarms are present, NO ACTIVE ALARMS will be shown. If alarms are present, all active Shutdown and Check alarms will be displayed under the ALARMS tab. Log alarms will be

displayed under the INFO tab. For additional information regarding the alarm shown on the display, select DETAIL. In the HMI Main Menu:

- Alarms will be listed with the highest severity alarms first/top in the alarm list. Alarms lower in the list have reduced fault severity.
- The HMI will display a Recommendation Action for each active alarm.

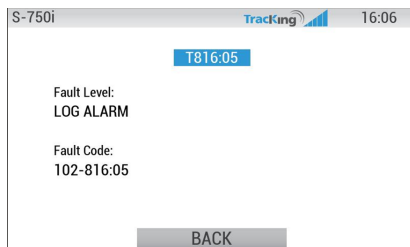
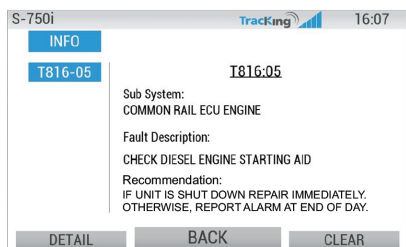
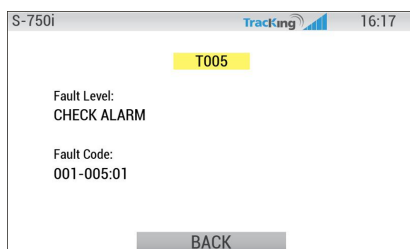
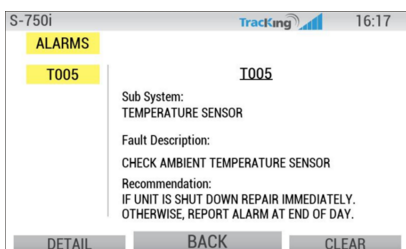
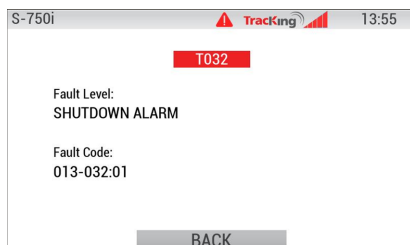
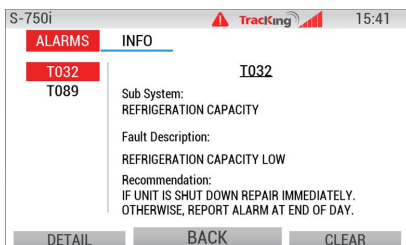

After the alarm situation is resolved, select CLEAR to clear the alarm. To display the next alarm, press the DOWN navigation key or press the LEFT/RIGHT navigation key to switch to the ALARM/INFO submenu.

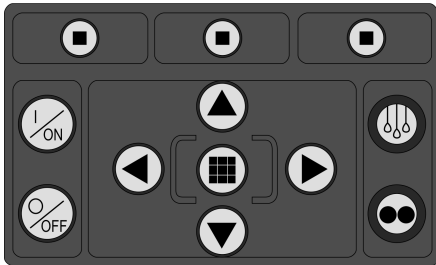

SAP1663

If a serious condition occurs, the unit will be shut down to prevent damage to the unit or the load. If this occurs, the display will show that the unit is shut down and display the alarm code that caused the shutdown. A Recommendation Action will be available for review for each alarm.

Clearing Alarm Codes

Most alarm codes can be cleared conventionally from the Alarm Menu using the CLEAR selection.

The following control and display sensor alarm codes can only be cleared from Main Menu + or Guarded Access Menu:

- Alarm Code 02 Check Evaporator Coil Sensor
- Alarm Code 03 Check Control Return Air Sensor
- Alarm Code 04 Check Control Discharge Air Sensor
- Alarm Code 128 Engine Run Time - Maintenance Reminder #1
- Alarm Code 129 Engine Run Time - Maintenance Reminder #2
- Alarm Code 130 Electric Run Time - Maintenance Reminder #1
- Alarm Code 131 Electric Run Time - Maintenance Reminder #2
- Alarm Code 132 Total Run Time - Maintenance Reminder #1
- Alarm Code 133 Total Run Time - Maintenance Reminder #2
- Alarm Code 134 Controller Power On Hours

The following alarm codes clear automatically:

- Alarm Code 44 Check Fuel System - Clears when the fuel level sensor detects that the fuel tank no longer has an excessively low fuel level (fuel tank refilled).
- Alarm Code 64 Pretrip Reminder - Clears when a Pretrip Test is performed.

-
- Alarm Code 91 Check Electric Ready Input - Clears automatically when electric power is restored.
 - Alarm Code 96 Low Fuel Level - Clears when the fuel level sensor detects that the fuel tank no longer has a low fuel level (fuel tank refilled).

Pretrip Alarms

If an alarm occurs during a Pretrip Test, Alarm code 28 (Pretrip Abort) will set as a Shutdown alarm alongside additional alarm code(s) which indicate the detailed specific failure mode(s).

Alarm Codes When Switching Between Diesel and Electric

If a shutdown alarm occurs that affects only diesel mode operation and the unit is switched to electric, the diesel mode shutdown alarm becomes an electric mode log alarm. This allows the unit to run in electric mode without clearing the shutdown alarm that is preventing diesel mode operation. If the unit is switched back to diesel mode, the alarm again become a diesel mode shutdown alarm and prevents unit operation.

In the same manner, if a shutdown alarm occurs that affects only electric mode operation and the unit is switched to diesel, the electric mode shutdown alarm becomes a diesel mode log alarm to allow diesel mode operation. If the unit is switched back to electric mode, the alarm reverts to an electric mode shutdown alarm and prevents unit operation. If the unit is configured for electric to diesel Auto-Switch, it automatically starts and runs in diesel mode if an electric shutdown occurs.

Important Alarm Notes

- If an alarm will not clear, the fault may still be active. If the fault is not corrected, the alarm will not clear or may be immediately reset.
- If an alarm cannot be cleared from the Main Menu, the Clear selection may not appear. These alarms must be cleared from Main Menu + or Guarded Access.
- All alarms must be viewed before any of the alarms can be cleared.

Flash Drive Menu

From the Standard Display, press the ACCEPT/ENTER center key. From the Main Menu screen select Flash Drive and press the ACCEPT/ENTER center key. Contact your Thermo King representative for more details.

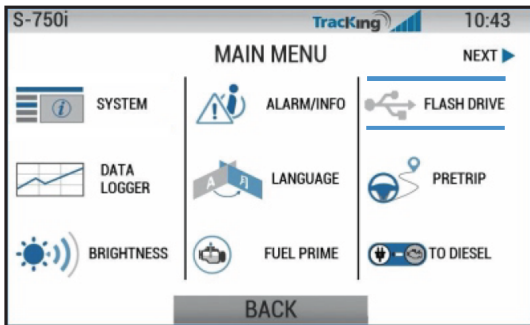

SAP2025

Download Submenu

The Download submenu allows the user to access the Temperature datalogger and ServiceWatch datalogger. Selecting Temperature datalogger allows access to download the temperature datalogger. The user may select any of the available options to configure the amount of data to download.

Note: A full download can take quite a long time to complete. It is recommended to only download necessary data when possible.

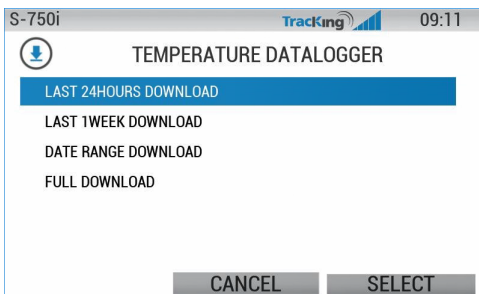
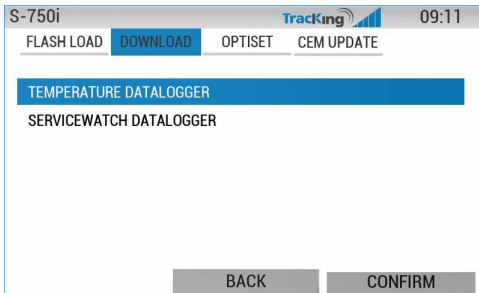

Selecting ServiceWatch datalogger allows access to download the ServiceWatch datalogger. A full download will download all available data. A quick download will download the latest block of data only.

Note: *The actual download amount will vary, based on current data block plus most recent compressed data block.*

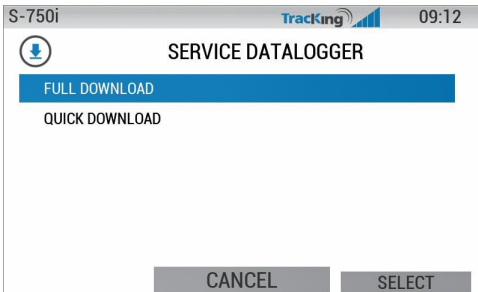
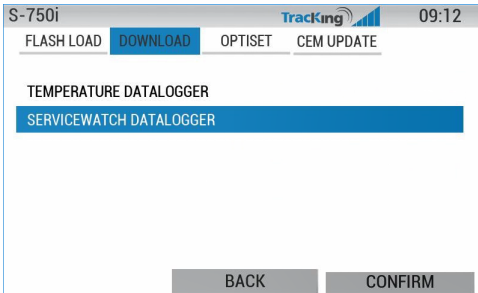

OptiSet Submenu

Contact your Thermo King representative for more information about OptiSet features.

S-750i Tracking  09:12

FLASH LOAD DOWNLOAD **OPTISET** CEM UPDATE

OPTISET SEND TO CONTROLLER

OPTISET RETRIEVE FROM CONTROLLER

BACK SELECT

CEM Update Submenu

Contact your Thermo King representative for more information about CEM features.

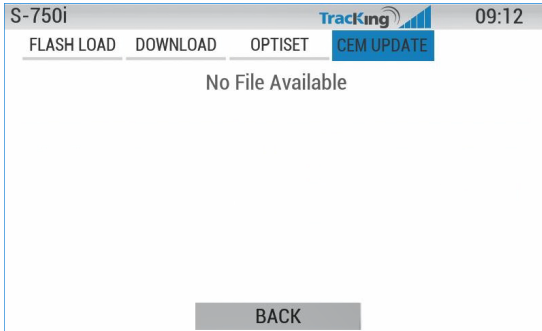

Language Menu

The Language menu allows the user to select a language from a list of up to three languages at one time. All subsequent displays are shown in the selected language. From the Standard Display, press the ACCEPT/ENTER center key. From the Main Menu screen, select Language and press the ACCEPT/ENTER center key.

Note: *English is the default language.*

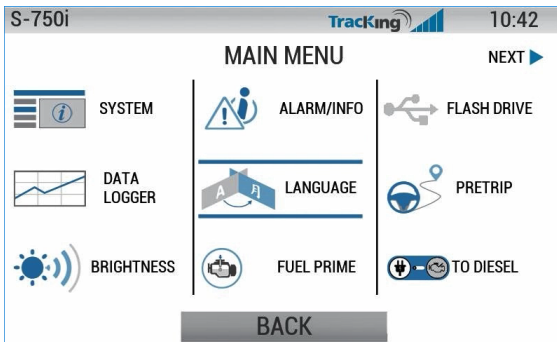

To change the language, use the navigation keys to scroll to the preferred language. Press the ACCEPT/ENTER key. The Standard Display with the chosen language will appear next.

Note: If no key is pressed in language prompt for 45 seconds, the current language will be retained and the HMI will transition to the Standard Display.

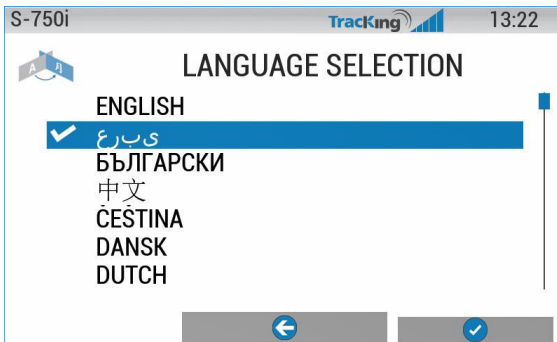

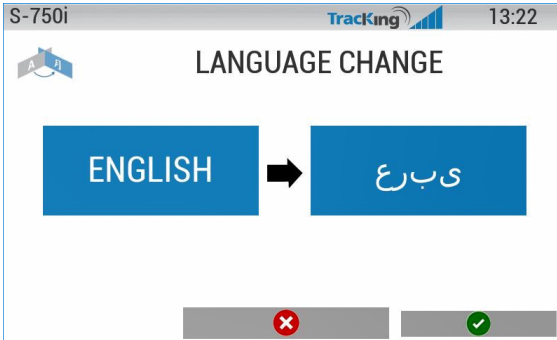

Pretrip Menu

A Pretrip Test verifies unit operation. This display allows a Pretrip Test to be selected and initiated by the operator. From the Standard Display, press the ACCEPT/ENTER center key. From the Main Menu screen select Pretrip and press the ACCEPT/ENTER center key.

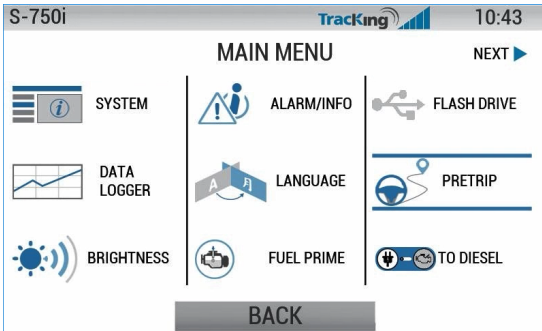

Brightness Menu

The brightness of the HMI screen (LCD) display and HMI keypad can be individually adjusted to allow for changing ambient light conditions. The choices available to the operator are HIGH, MEDIUM, LOW, and OFF. OFF actually results in a very dim screen suitable for low light conditions.

Important: Before replacing an HMI with no backlight, check the Backlight feature to verify the backlight is turned on.

Operation

From the Standard Display, press the ACCEPT/ENTER center key. From the Main Menu screen select Brightness and press the ACCEPT/ENTER center key.

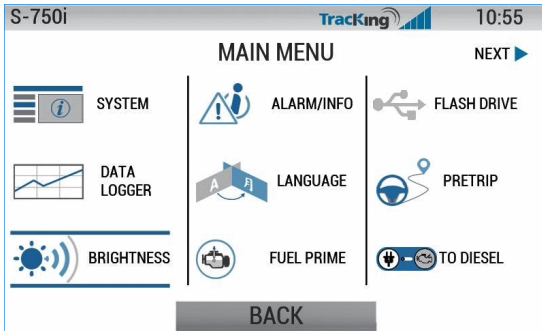

The Brightness options will appear. Select either LCD or Keypad and use the left or right keys to make a selection for brightness. When the desired brightness is shown, select ACCEPT. The Brightness change will briefly be confirmed.

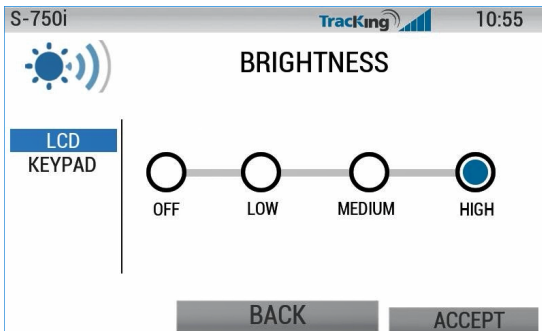

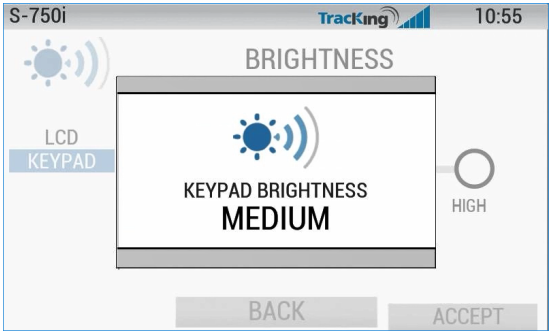
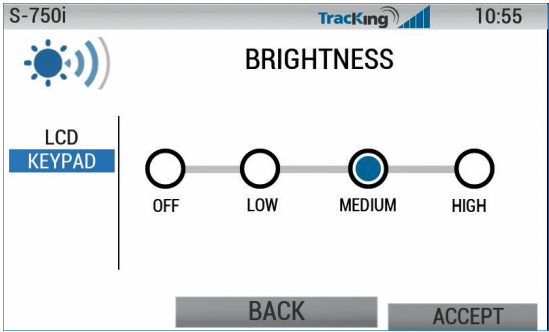

Fuel Prime Menu

The Fuel Prime function runs the fuel pump for up to five minutes to prime the fuel lines. Fuel priming is always shown on the HMI, but the functionality will only be available if the engine/electric motor is not running. From the Standard Display, press the ACCEPT/ENTER center key. From the Main Menu screen select Fuel Prime and press the ACCEPT/ENTER center key.

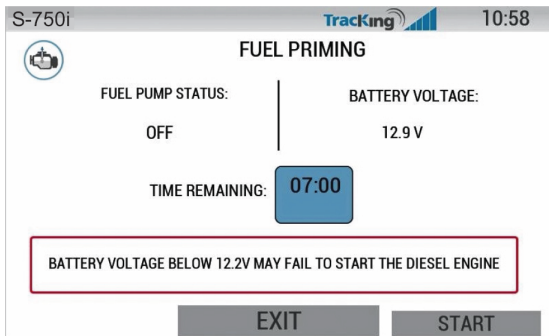
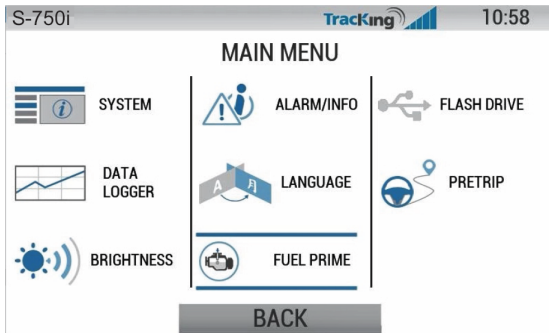

Electric Standby or Diesel Mode Menu





PROGRAMMING DIESEL MODE
PLEASE WAIT...



DIESEL ENGINE
STARTING



PROGRAMMING ELECTRIC MODE
PLEASE WAIT...

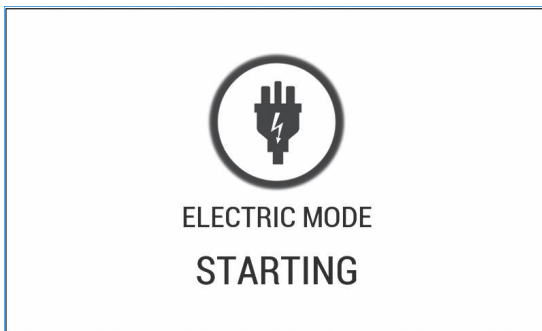
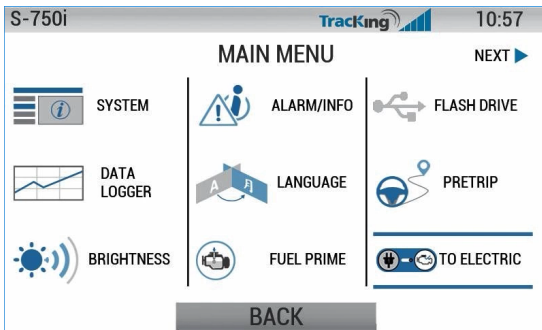

Sleep Mode

If this feature enabled in Guarded Access > Main Menu Configuration, the operator can select and set Sleep Mode from the Mode Menu. Sleep Mode is used to keep the engine warm and the battery charged when the unit is not in use. When the unit is Sleep Mode, the display will show "SLEEP" and the current time. To turn the feature on, from the Main Menu choose Sleep Mode.

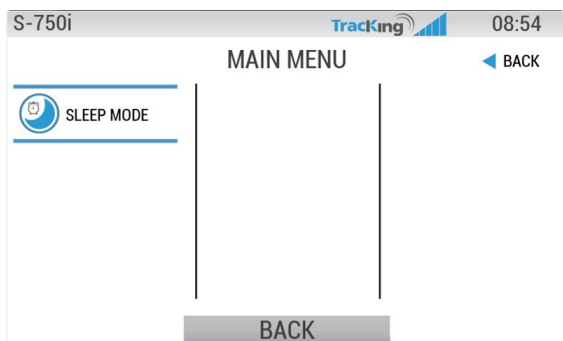

The following features are available in Sleep Mode.

- **Program Wakeup Time:** This feature allows a wakeup time to be specified. When the selected time is reached, the unit will start and resume normal operation.
 - Day to Wake Up: This feature allows the day the unit is to wake up to be specified.
 - Hour to Wake Up: This feature allows the hour the unit is to wake up to be specified.
 - Minute to Wake Up: This feature allows the minute the unit is to wake up to be specified.

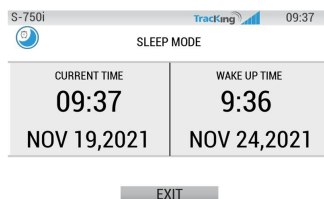
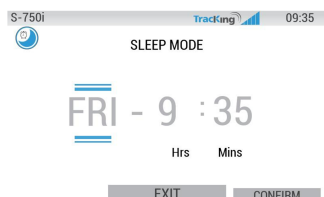
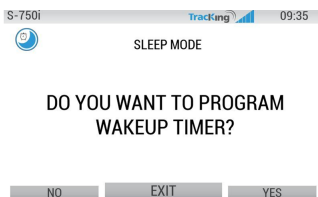

Manual Pretrip Inspection and Loading Procedures

The following Manual Pretrip Inspection should be completed before starting the unit and loading the trailer. While the pretrip inspection is not a substitute for regularly scheduled maintenance inspections, it is an important part of the preventive maintenance program designed to head off operating problems and breakdowns before they happen.

Fuel: The diesel fuel supply must be adequate to guarantee engine operation to the next check point.

Engine Oil: The engine oil level should be at the FULL mark with the dipstick turned (threaded) into oil pan. Never overfill.

▲ CAUTION

Hazardous Pressures!

Do not remove expansion tank cap while coolant is hot.

NOTICE

System Contamination!

Do not add "GREEN" or "BLUE-GREEN" conventional coolant to cooling systems using "RED" Extended Life Coolant, except in an emergency. If conventional coolant is added to Extended Life Coolant, the coolant must be changed after 2 years instead of 5 years.

Coolant: The engine coolant must have antifreeze protection to -30 F (-34 C). Alarm Code 37 indicates low coolant. Add coolant in the expansion tank.

Battery: The terminals must be clean and tight.

Belts: The belts must be in good condition and adjusted to the proper tensions.

Electrical: The electrical connections should be securely fastened. The wires and terminals should be free of corrosion, cracks, or moisture.

Structural: Visually inspect the unit for leaks, loose or broken parts, and other damage. The condenser and evaporator coils should be clean and free of debris. Check the defrost drain hoses and fittings to make sure they are open. Verify all the doors are latched securely.

Coils: The condenser and evaporator coils must be clean and free of debris.

Cargo Box: Check the interior and exterior of the cargo box for damage. Any damage to the walls or insulation must be repaired.

Manual Pretrip Inspection and Loading Procedures

Cargo Doors: Verify the cargo doors and weather seals are in good condition. The doors should latch securely and the weather seals should fit tightly.

Defrost Drains: Check the defrost drain hoses to make sure they are open.

Loading and Inspection Procedures

This chapter describes pre-loading inspections, loading procedures, post-loading procedures, post-loading inspections, and enroute inspections. Thermo King refrigeration units are designed to maintain the required product load temperature during transit. Follow these recommended loading and enroute procedures to help minimize temperature related problems.

Note: *When in doubt as to the correct refrigeration requirements and/or loading procedures, call your company office for instructions.*

Pre-Loading Inspection

1. Pre-cool products before loading. Note any variances on the manifest.
2. Inspect door seals and vent doors for condition and a tight seal with no air leakage.
3. Inspect the trailer inside and out. Look for:
 - Damaged or loose trailer skin and insulation
 - Damaged walls, air ducts, floor channels, or “T” flooring
 - Clogged defrost drain tubes
 - Blocked return air bulkhead
4. Verify that the setpoint temperature is correct for your cargo. Pre-cool the trailer as required.
5. Supervise product loading to ensure sufficient air space around and through the load. Airflow around cargo must not be restricted.

Note: *If the warehouse is not refrigerated, operate the unit with the doors closed until cargo is ready to be loaded. Then turn off the unit, open the cargo doors and load cargo. When cargo is loaded, close trailer doors and restart the unit. The unit can be operated with the cargo box doors open if the truck is backed into a refrigerated warehouse and the dock door seals fit tightly around the trailer.*

Figure 15. Loading Considerations

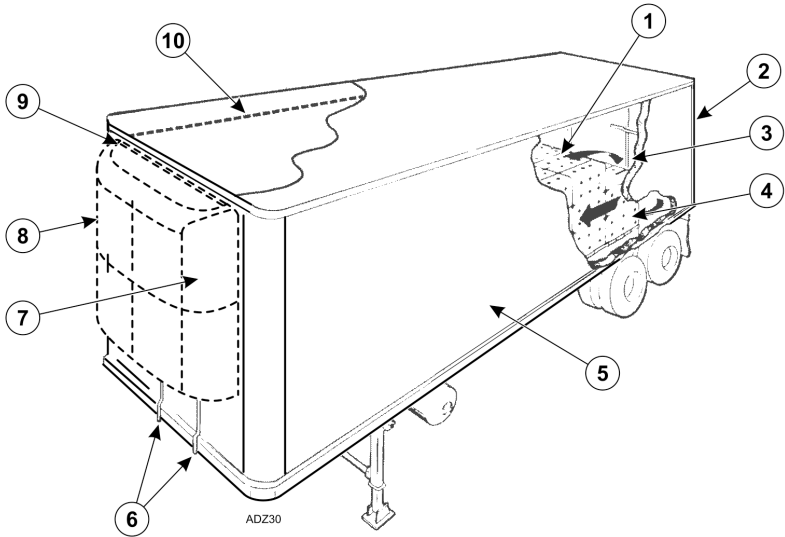

1.	Correct load height (trailers without chutes)	6.	Clear defrost drains
2.	Tight doors and seals	7.	Good outside air circulation
3.	Good air circulation around load	8.	Unit inspection
4.	Proper cargo temperature (prior to loading)	9.	Tight seals
5.	Interior/exterior walls and insulation in good condition	10.	Maximum load height followed

Post-Loading Inspection

Post-loading inspections verify the cargo has been loaded properly. To perform a post-load inspection:

1. Inspect the evaporator outlets for blockage.
2. Turn the unit off before opening the cargo box doors to maintain efficient operation.

Manual Pretrip Inspection and Loading Procedures

Note: *The unit can be operated with the cargo box doors open if the truck is backed into a refrigerated warehouse and the dock door seals fit tightly around the trailer.*

3. Perform a final check of the load temperature. If the load is above or below temperature, make a final notation on the manifest.

Important: *Cargo must be pre-cooled to proper temperature before loading. The unit is designed to maintain temperature, not cool an above-temperature load.*

4. Close or supervise the closing of the cargo box doors. Verify they are securely locked.
5. Verify the setpoint is at the temperature listed on the manifest.
6. If the unit was stopped, restart using the correct starting procedure. See the Operating Instruction chapter in this manual.
7. Start a manual defrost cycle 30 minutes after loading. See the Manual Defrost procedure in the manual.

Enroute Inspections

Complete the following enroute inspection every four hours. This will help minimize temperature related problems.

Inspection Procedure

1. Verify setpoint is correct.
2. Check the return air temperature reading. It should be within the desired temperature range.
3. Initiate a manual defrost cycle after each enroute inspection.

Inspection Troubleshooting

1. If a temperature reading is not within the desired temperature range, refer to the troubleshooting table ([Table 2, p. 76](#)). Correct problem as required.
2. Repeat the Enroute Inspection every 30 minutes until the compartment temperature is within the desired temperature range. Stop the unit if the compartment temperature is not within the desired temperature range on two consecutive 30 minute inspections, especially if the compartment temperature appears to be moving away from the setpoint.
3. Immediately contact the nearest Thermo King Service Center or your company office.
4. Take all necessary steps to protect and maintain proper load

Manual Pretrip Inspection and Loading Procedures

temperature.

NOTICE

Cargo Loss!

Stop the unit if the compartment temperature remains higher than the desired temperature range from the setpoint on two consecutive 30 minute inspections. Contact the nearest Thermo King Service Center or your company office immediately. Take all necessary steps to protect and maintain proper load temperature.

Table 2. Inspection Troubleshooting

Problem: A return air temperature reading is not within desired temperature range of the setpoint.	
Cause	Remedy
The unit has not had time to cool down to correct temperature.	Refer to the load log history. Look for above temperature load records, properly pre-cooled cargo compartment, length of time on road, etc. Correct as required. Continue monitoring return air temperature until the reading is within the desired temperature range of the setpoint.
The unit may have a low refrigerant charge.	Check the receiver tank sight glass for refrigerant level. If fluid is not showing in the receiver tank sight glass, the refrigerant charge may be low. A competent refrigeration technician is required to add refrigerant or repair the system. Contact the nearest Thermo King dealer, authorized Service Center, or call the Thermo King Cold Line for referral. Consult the Table of Contents for Cold Line information.
The unit is in defrost or has just completed a defrost cycle.	Monitor the return air temperature after the defrost cycle is completed to see if the temperature returns to the desired temperature range of the setpoint.
The evaporator is plugged with frost.	Initiate a manual defrost cycle. The defrost cycle will automatically terminate when complete. Continue monitoring the return air temperature until the reading is within the desired temperature range of the setpoint.
Improper air circulation in the cargo compartment.	Inspect the unit and cargo compartment to determine if the evaporator fan (3) are working properly circulation the air. Poor air circulation may be due to improper loading of the cargo, shifting of the load, or depending on unit, fan belt slippage or faulty electrical fans. Correct as required. Continue monitoring return air temperature until problem is corrected.

Manual Pretrip Inspection and Loading Procedures

Table 2. Inspection Troubleshooting (continued)

Problem: A return air temperature reading is not within desired temperature range of the setpoint.	
Cause	Remedy
The unit did not start automatically.	Determine the cause for not starting. Correct as required. Continue monitoring return air temperature until reading is within desired temperature range of the setpoint.

Jump Starting

If unit battery is discharged or run down, unit may be jump started using jumper cables and another battery or vehicle. Consider the following precautions and be careful when jump starting a unit.

⚠ WARNING

Personal Protective Equipment (PPE) Required!

A battery can be dangerous. A battery contains a flammable gas that can ignite or explode. A battery stores enough electricity to burn you if it discharges quickly. A battery contains battery acid that can burn you. Always wear goggles or safety glasses and personal protective equipment when working with a battery. If you get battery acid on you, immediately flush it with water and get medical attention.

⚠ CAUTION

Hazard of Explosion!

Unhook the semi tractor from the trailer before using the tractor to jump start the unit on the trailer. The negative ground circuit is complete when the tractor is hooked to the trailer. This can cause dangerous sparks when the positive connection is made at the battery.

Important: *Make sure to use a 12 volt battery to jump start unit. If you are using a vehicle, make sure it has a 12 volt battery with a negative ground system. Do not use a "hot shot" booster device or a 24 volt source.*

Read and understand the following procedure completely before connecting and jumper cables. Use good jumper cables made with #2 gauge (or larger) cables.

1. Verify unit is turned off. If you are using a vehicle, verify its ignition is also turned off.
2. Open front doors on unit. Battery is located on the right of engine.
3. Check discharged battery to verify it is not damaged or frozen. Do not jump start a damaged or frozen battery. Check vent caps to verify they are tight.
4. Identify positive (+) and negative (-) battery terminals.
5. Remove red cover from positive (+) battery terminal on the unit's battery.

Figure 16. Sequence for Connecting Jumper Cables

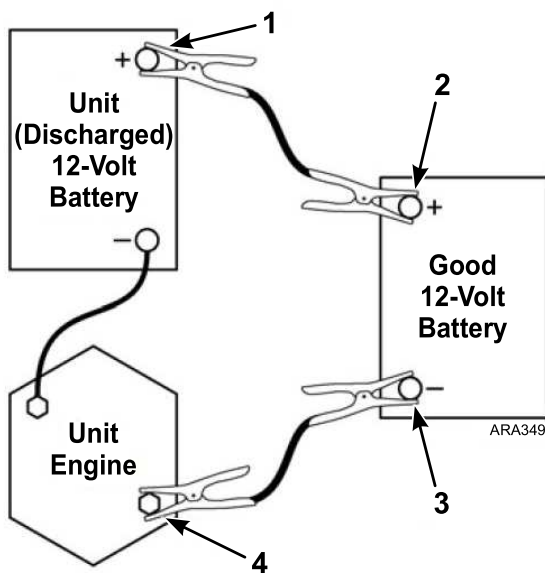

1.	Positive (+) Terminal on Unit Battery
2.	Positive (+) Terminal on Good Battery
3.	Negative (-) Terminal on Good Battery
4.	Starter Mounting Bolt on Unit Engine

6. Connect the red positive (+) jumper cable to the positive (+) battery terminal on the unit's battery. Do not let the other end of the jumper cable touch anything that conducts electricity.

⚠ WARNING

Hazard of Explosion!

Allowing the positive (+) jumper cable to short to ground can produce dangerous sparks.

7. Connect the other end of the red positive (+) jumper cable to the positive (+) battery terminal on the good battery.

Jump Starting

8. Connect the black negative (-) jumper cable to the negative (-) battery terminal on a good battery. Do not let the other end of the jumper cable touch anything that conducts electricity.
9. Connect the black negative (-) jumper cable to the lower starter mounting bolt on the unit's engine.
10. If you are using a vehicle to jump start the unit, start the vehicle and let it run for a few minutes. This will help charge the discharged battery.

DANGER

Risk of Injury!

Keep your hands, clothing, and tools clear of fans and/or belts when working on a unit that is running or when opening or closing compressor service valves. Loose clothing might entangle moving pulleys or belts, causing serious injury or possible death.

11. Turn the unit on and let it start automatically or start it manually. If the unit will not crank or start, contact a qualified technician.
Note: Some units with microprocessors will show an alarm code and will not try to start the unit until battery voltage is above 10 volts.
12. After the unit starts, remove the jumper cables in reverse order: black negative (-) from the unit starter mounting bolt, black negative (-) from the good battery, red positive (+) from the good battery, and red positive (+) from the unit battery (that was discharged).

Figure 17. Sequence for Disconnecting Jumper Cables

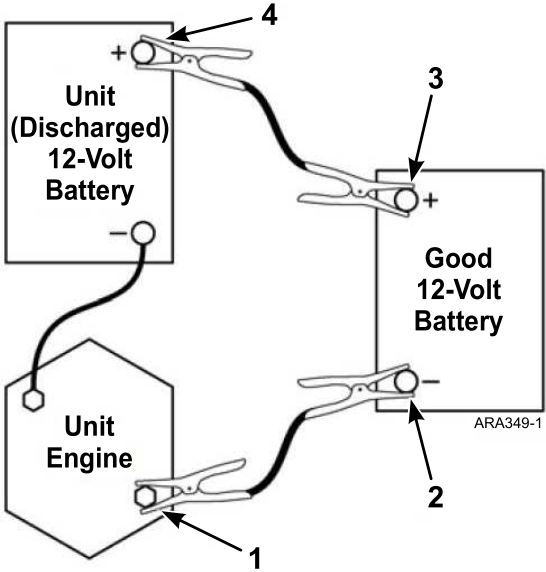

1.	Starter Mounting Bolt on Unit Engine
2.	Negative (-) Terminal on Good Battery
3.	Positive (+) Terminal on Good Battery
4.	Positive (+) Terminal on Unit Battery

Specifications

Engine

Model/Engine	TK488CR1 (Tier 4)
Fuel Type	No. 2 diesel fuel under normal conditions No. 1 diesel fuel is acceptable cold weather fuel Note: <i>The sulfur content must be less than or equal to 15 ppm, the fuel must be free of zinc, and comply with the latest release of ASTM D975, EN 590, or JIS K2204.</i>
Oil Capacity	12 quarts (11.4 liters) crankcase and oil filter Fill to full mark on dipstick
Oil Type	API Classification CJ-4 or CK-4 ACEA Rating E6 Note: <i>This oil type must be used together with ULSD fuel to prevent damage to the DOC.</i>
Recommended oil viscosity based on ambient temperature	14 F to 122 F (-10 C to 50 C): SAE 15W-40 (Synthetic) 5 to 104 F (-15 to 40 C): SAE 15W-40 5 to 104 F (-15 to 40 C): SAE 10W-30 (Synthetic or Synthetic Blend) -13 to 104 F (-25 to 40 C): SAE 10W-40 -13 to 86 F (-25 to 30 C): SAE 10W-30 -22 to 122 F (-30 to 50 C): SAE 5W-40 (Synthetic) Below -22 F (-30 C): SAE 0W-30 (Synthetic)
Engine Coolant Type	Chevron/Delo XLC - a nitrite-free Extended Life Coolant (ELC) Use a 50/50 concentration
<div style="background-color: black; color: white; padding: 5px; font-weight: bold; font-size: 1.2em;">NOTICE</div> <div style="border: 1px solid black; padding: 10px;"> <p>System Contamination!</p> <p>Do not add other types of coolant to cooling systems using Chevron/Delo XLC except in an emergency. If another type of coolant is added, the coolant must be changed to Chevron/Delo XLC when available.</p> </div>	
Coolant System Capacity	7.5 quarts (7.1 liters)
Radiator Cap Pressure	15 psig (103 kPa)
Engine Coolant Thermostat	160 F (71 C)

Refrigeration System

Contact your Thermo King dealer for refrigeration system service or maintenance.

Electrical Control System

Low Voltage	12.5 Vdc
High Voltage	327 Vac from AC generator at engine low speed. 537 Vac from AC generator at engine high speed.
	 DANGER Hazardous Voltage! All inspection or service procedures of the high voltage systems should only be done by an authorized Thermo King dealer.
Battery	<p>One, Group C31, 12 volt battery. The battery must be suitable for deep cycling, heavy duty and rated with a minimum of 95 amp/hr. Thermo King ReliaMax 925N (925 CCA) wet cell battery is recommended for both warm and cold climates. Thermo King EON (1150 CCA) AGM battery is recommended for extreme climates and for Rail Ready (RR), Domestic Refrigerated Container (DRC), and Trailer on Flat Car (TOFC) applications.</p> <p>Note: <i>If the unit is not going to be used for an extended period of time, turn the Microprocessor On/Off Power Switch to the OFF position to maximize battery life.</i></p>
Fuses	Refer to "Unit Protection and Control Devices," p. 28.
Battery Charger 30 Amp (Standard Equipment)	30 amp, Bulk = up to 15.0v. Absorption = temperature compensation from 14.15v @ 77F (25 C), Float Voltage = Stage 3 @ ~ 13.6v ~ 13.8v When absorption current drops below 2.5A, operation mode changes to floating. Both absorption and floating voltages are temperature compensated.
Battery Charger 120 Amp (Optional Equipment, Supplemental power kit)	120 amp (limited to 60A output), up to 15.0v, Absorption = temperature compensation from 14.15v @ 77F (25 C), Float Voltage = Stage 3 @ ~ 13.6v ~ 13.8v When absorption current drops below 2.5A, operation mode changes to floating. Both absorption and floating voltages are temperature compensated.

Standby Power Cord Requirements

Supply Circuit Breaker	460/3/60 (Hermetic Scroll Compressor – 30 amps (1))
Extension Cord Size	460/3/60 (Hermetic Scroll Compressor – Type W or SOOW, 10 AWG (2))
(1) HACR/Motor Circuit Breaker Recommended, Consult a Licensed Electrician (2) 25 ft (7.5m) permitted without cable management, 75 ft. (22.8 m) Max recommended permitted with approved cable management system	

Maintenance Inspection Schedule

Pretrip	Every 1,500 Hours	Every 3,000 Hours*	Annual/ 4,500 Hours	As Needed	Inspect/Check/Service These Items
					Microprocessor:
•					Run Pretrip Test. (see "Performing a Pretrip Test").
					Engine:
•					Check fuel supply.
•					Check engine oil level.
•	•	•	•		Inspect belts for condition and proper tension.
•	•	•	•		Check engine oil pressure hot, on high speed (should display "OK").
•	•	•	•		Listen for unusual noises, vibrations, etc.
•	•	•	•		Check engine coolant level and antifreeze protection (-30 F [-40 C]).
	•	•	•		Drain water from fuel tank and check vent.
	•	•	•		Inspect/clean the fuel strainer / pressure regulator assembly prefilter screen.
	•	•	•		Check condition of drive coupling bushings.
			•		Check engine mounts for wear.
		•			Replace EMI 3000 air cleaner element (see "EMI 3000 Air Cleaner") at 3,000 hours or two years (whichever occurs first). See Note.
		•			Replace the primary and secondary fuel filters. See Note.

Maintenance Inspection Schedule

Pretrip	Every 1,500 Hours	Every 3,000 Hours*	Annual/ 4,500 Hours	As Needed	
Inspect/Check/Service These Items					
				•	Drain water separator as needed. Alarm Code 517 indicates water level high and separator needs draining.
		•			Change engine oil and oil filter (hot). Requires oil with API Classification CJ-4 or CK-4. See Note.
				•	Adjust engine valve clearance.
				•	Inspect and clean the EGR system as necessary. No scheduled EGR system maintenance is required. Alarm Code 570 will display when the EGR system needs cleaning. If cleaning is not completed when Code 570 is active, eventually, the EGR Valve deposit accumulation limit will be reached, and an EGR Valve Alarm Code 618 (P148A) will be set, and the engine operation will be limited to default running mode, low-speed and 75% max-available torque, only. Alarm Code 618 means that the accumulated deposit amount has exceeded the allowable limit. If Code 618 occurs on an engine with less than 5,000 total engine hours, clean the EGR Valve and Cooler as necessary to eliminate the Alarm Code.
			—		Change ELC (red) engine coolant every 5 years or 12,000 hours. Units equipped with ELC have an ELC nameplate on the expansion tank (see "Engine Cooling System").
<p>Note: Units equipped with Severe Duty Filtration Package - Replace air cleaner element, replace fuel filter/water separator, and change engine oil and oil filter every 4,000 hours.</p>					
					Electrical:
	•	•	•		Inspect battery terminals and electrolyte level.
	•	•	•		Inspect wire harness for damaged wires or connections.
	•	•	•		Inspect AC generator and alternator wire connections for tightness.

Maintenance Inspection Schedule

Pretrip	Every 1,500 Hours	Every 3,000 Hours*	Annual/ 4,500 Hours	As Needed	
					Inspect/Check/Service These Items
			•		Inspect electric motors.
			•		Inspect and, if required, re-torque all electrical connections on the contactors in the Fan Control Box to 15 in-lb (1.7 N•m).
					Refrigeration:
•	•	•	•		Check refrigerant level.
	•	•	•		Check for proper suction pressure.
	•	•	•		Check compressor oil level and condition.
			•		Check compressor efficiency and pump down refrigeration system.
				•	Replace filter / drier and check discharge and suction pressure every two (2) years.
					Structural:
•	•	•	•		Visually inspect unit for fluid leaks.
•	•	•	•		Visually inspect unit for damaged, loose, or broken parts (includes air ducts and bulkheads).
	•	•	•		Visually inspect the top of the unit for debris, soot build up, branches, and bird nesting material – remove debris.
	•	•	•		Clean entire unit including condenser and evaporator coils and defrost drains.
	•	•	•		Check all unit and fuel tank mounting bolts, brackets, lines, hoses, etc.

Serial Number Locations

Unit: Nameplates are located on the frame near the battery, and on the roadside evaporator frame.

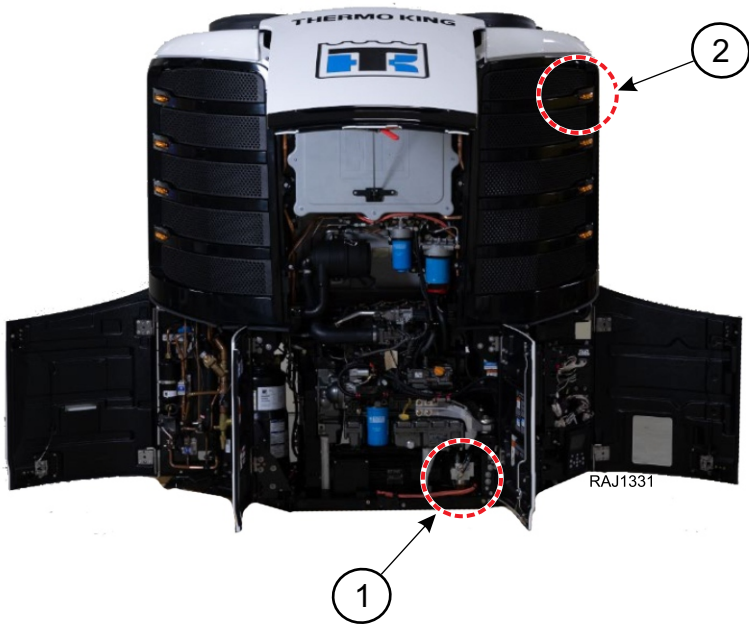

1.	On Frame In Engine Compartment
2.	On Evaporator Housing

Serial Number Locations



ARA2013

1.	Unit Serial Number
2.	Unit Model
3.	Bill of Material Number

Engine: Engine identification plate is located on the engine valve cover or on the side of the engine oil sump.

Important: Many engine components are not interchangeable between the different engine models. See the appropriate parts manual or the EPC (Electronic Parts Catalog) to identify the correct service parts.

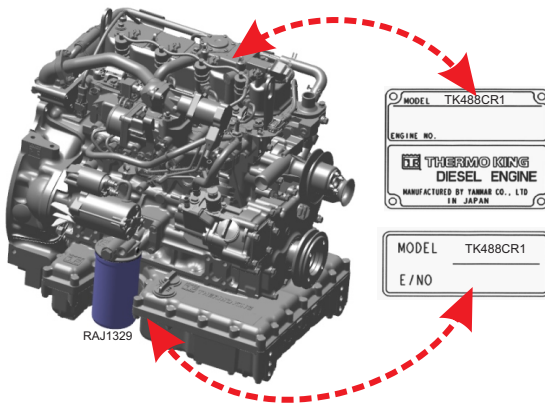

Serial Number Locations

Scroll Compressor: Identification plate is located on the compressor body, above the terminal block.

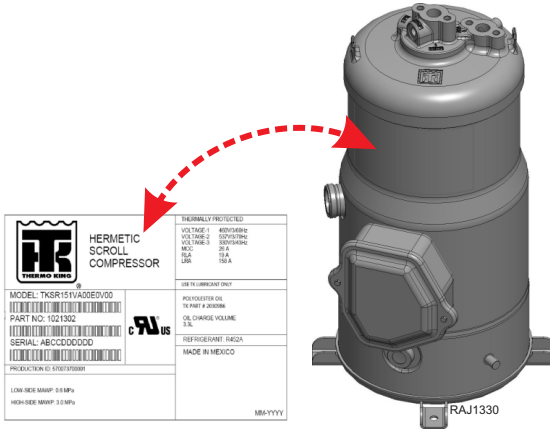

Emergency Cold Line

If you can't get your unit operating and need assistance, you can locate a Thermo King Dealer anywhere in the United States by going to thermoking.com or by using the Thermo King North American Service Directory (available from any Thermo King dealer). If you are unable to reach a dealer, then call the Toll Free Emergency Cold Line Number (888) 887-2202. The answering service will assist you in reaching a dealer to get the help you need. The Cold Line is answered 24 hours a day by personnel who will do their best to get you quick service at an authorized Thermo King Dealer



RCS358

Warranty

Please contact your nearest Thermo King dealer for terms of the Thermo King North American Trailer Unit Limited Warranty. Refer to TK 56445-9-CH.

EPA and ARB Supplemental Emissions Warranty Statement

Your Thermo King unit is covered by the diesel engine manufacturer's EPA and ARB Supplemental Emissions Warranty. Complete details of this emission warranty can be found at www.thermoking.com.

Thermo King – by Trane Technologies (NYSE: TT), a global climate innovator – is a worldwide leader in sustainable transport temperature control solutions. Thermo King has been providing transport temperature control solutions for a variety of applications, including trailers, truck bodies, buses, air, shipboard containers and railway cars since 1938. For more information, visit www.thermoking.com or www.tranetechnologies.com.

Thermo King has a policy of continuous product and product data improvements and reserves the right to change design and specifications without notice. We are committed to using environmentally conscious print practices.